



WIN

PRODOTTI VINCENTI

**CATALOGO GENERALE
2019/2020**



WIN

PRODOTTI VINCENTI



*"Il valore di un premio,
la passione e la creatività del lavoro svolto per realizzarlo,
possono rendere uniche ed irripetibili le vostre premiazioni."*

ICONE



PRODOTTO
DI MAGGIORE VENDITA



PRODOTTO
DI DIMENSIONE MAGGIORE
ALL'INTERNO DELLA LINEA



PRODOTTO
PER SUBLIMAZIONE



PRODOTTO
PER INCISIONE



BORDO TAZZA
IN METALLO SMUSSATO



TAZZA IN ABS



TAZZA LASER



PALLA IN METALLO



BASE MARMO
MADE IN ITALY



BASE MARMO NERO
MADE IN ITALY



BASE IN ABS



MATERIALE
METACRILATO
CON STAMPA A COLORI



MATERIALE
RESINA



MATERIALE
CRISTALLO



MATERIALE
VETRO



MATERIALE
LEGNO



MATERIALE
CERAMICA

**TROFEI****Pag. 2-71**

LINEA PARTECIPAZIONE
 LINEA CALCIO
 TROFEI CONVENIENZA

Pag. 2-36
 Pag. 23-27 | 37-48 | 161-167
 Pag. 49-71

COPPE**Pag. 72-167**

LINEA PARTECIPAZIONE
 LINEA CONVENIENZA
 LINEA COMMERCIALE
 LINEA CLASSICA COPPE
 LINEA CLASSICA LASER
 LINEA CLASSICA CALCIO

Pag. 72-83
 Pag. 84-95
 Pag. 96-118
 Pag. 119-141
 Pag. 142-160
 Pag. 161-167

TROFEI VETRI E CRISTALLO**Pag. 168-174****TARGHE SUPPORTI E CORNICI****Pag. 175-199**

SUPPORTI PER TARGHE, DISCHI E SCUDI
 CORNICI PORTA TARGA
 TARGHE PER STAMPA ED INCISIONE

Pag. 175-191
 Pag. 192-194
 Pag. 195-199

MATERIALE DI CONSUMO**Pag. 200****MEDAGLIE ED ACCESSORI****Pag. 201-228**

COCCARDE E SPILLE
 MEDAGLIE
 NASTRI ED ACCESSORI
 MAGNETI PERSONALIZZATI

Pag. 201
 Pag. 202-227
 Pag. 210-216
 Pag. 228

ACRYCOLOR PERSONALIZZATO**Pag. 229-259**

MEDAGLIE E TROFEI
 TARGHE A MURO/ESPOSITORI

Pag. 230-255
 Pag. 256-258

INDICE PRODOTTI ALFANUMERICO**Pag. 260**



ABBINA IL TROFEO CON LA MEDAGLIA

SERIE

90001 Trofeo
29001 Medaglia

**Personalizza la tua premiazione
nella forma e nel colore**

TAGLIO LASER
STAMPA DIGITALE AD ALTA DEFINIZIONE

Con questa collezione di Trofei
potrai avere la medaglia abbinata.
Premia tutti i partecipanti.

Il tuo evento non passerà inosservato !

MATERIALE METACRILATO SPESSORE 3 mm
QUATTRO COLORI
Oro. Argento. Bronzo FINITURA METALLO

PERSONALIZZAZIONE

- NESSUN MINIMO D'ORDINE RICHIESTO
- COSTI PER REALIZZAZIONE IMPIANTO
MESSA IN MACCHINA
ELABORAZIONE GRAFICA A PROGETTO

Esempio di
personalizzazione





TROFEO
90001

	Art.	H/mm	L/mm
	-1	140	70
	-2	160	80
	-3	180	90
	-4	120	100
	-5	130	110
	-6	150	120

B-S-G: RETRO MEDAGLIA NERO LUCIDO
NESSUN MINIMO D'ORDINE RICHIESTO



MEDAGLIA
29001

	Art.	H/mm	L/mm
	-1	60	60
	-2	70	70
	-3	70	50
	-4	80	65

B-S-G: RETRO MEDAGLIA NERO LUCIDO
NESSUN MINIMO D'ORDINE RICHIESTO

RI9901-1 SPESSORE 22 mm
LUNGHEZZA 920 mm

MIN 50 Pz. +150 Pz. +300 Pz.

NASTRO PERSONALIZZATO:

Stampa in quadricromia bilaterale.
Tessuto raso alta qualità.
Possibilità di abbinare il nastro con la medaglia Art. 29001-2-3-4-5-6-7.

Ordinare separatamente.
15gg. lavorativi per la produzione





TROFEO TONDO
90002-1

Art.	HxL/mm
-1B	140x90
-1S	140x90
-1G	140x90

Art. RI9901-1 Nastro personalizzato vedi Pag. 3

TROFEO RETTANGOLARE
90003-1

Art.	HxL/mm
-1B	150x80
-1S	150x80
-1G	150x80



TROFEO QUADRATO
90004-1

Art.	HxL/mm
-1B	140x90
-1S	140x90
-1G	140x90

ABBINA IL TROFEO CON LA MEDAGLIA

Personalizza la tua premiazione nel colore

STAMPA DIGITALE AD ALTA DEFINIZIONE

SERIE

90002-90003-90004 Trofeo
29002- 29003 - 29004 Medaglia

MATERIALE METACRILATO SPESSORE 3 mm
QUATTRO COLORI
Oro. Argento. Bronzo FINITURA METALLO
Bianco Neutro
SCEGLI TRA TRE FORME E STAMPA

PERSONALIZZAZIONE

- NESSUN MINIMO D'ORDINE RICHIESTO
- COSTI PER MESSA IN MACCHINA ELABORAZIONE GRAFICA A PROGETTO



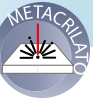

MEDAGLIA
29002-1 99

Art.	Ø/mm
● -G	60
● -S	60
● -B	60
○ -w	60

B-S-G: RETRO MEDAGLIA NERO LUCIDO
NESSUN MINIMO D'ORDINE RICHIESTO



PERSONALIZZAZIONE

- NESSUN MINIMO D'ORDINE RICHIESTO
- COSTI PER MESSA IN MACCHINA, ELABORAZIONE GRAFICA A PROGETTO.



MEDAGLIA
29003-1 99

Art.	HxL/mm
● -G	70x50
● -S	70x50
● -B	70x50
○ -w	70x50

B-S-G: RETRO MEDAGLIA NERO LUCIDO
NESSUN MINIMO D'ORDINE RICHIESTO



MEDAGLIA
29004-1 99

Art.	HxL/mm
● -G	65X65
● -S	65X65
● -B	65X65
○ -w	65X65

B-S-G: RETRO MEDAGLIA NERO LUCIDO
NESSUN MINIMO D'ORDINE RICHIESTO



**ESAGONO
90006-1**

Art.	HxL/mm
-1B	140x90
-1S	140x90
-1G	140x90



**TONDO
90005-1**

Art.	HxL/mm
-1B	140x90
-1S	140x90
-1G	140x90



**ABBINA IL TROFEO
CON LA MEDAGLIA**

**Personalizza la tua premiazione
nel colore**

STAMPA DIGITALE AD ALTA DEFINIZIONE

SERIE

90005-90006-90007 Trofeo
29005- 29006 - 29007 Medaglia

MATERIALE METACRILATO SPESSORE 3 mm
QUATTRO COLORI

Oro. Argento. Bronzo FINITURA METALLO
Bianco Neutro

SCEGLI TRA TRE FORME E STAMPA

PERSONALIZZAZIONE

- NESSUN MINIMO D'ORDINE RICHIESTO
- COSTI PER MESSA IN MACCHINA
ELABORAZIONE GRAFICA A PROGETTO



**OVALE
90007-1**

Art.	HxL/mm
-1B	140x90
-1S	140x90
-1G	140x90





TONDO 29005-1 99

Art.	Ø/mm
● -G	60
● -S	60
● -B	60
○ -w	60

B-S-G: RETRO MEDAGLIA NERO LUCIDO
NESSUN MINIMO D'ORDINE RICHIESTO

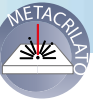

ESAGONO 29006-1 99

Art.	Ø/mm
● -G	60
● -S	60
● -B	60
○ -w	60

B-S-G: RETRO MEDAGLIA NERO LUCIDO
NESSUN MINIMO D'ORDINE RICHIESTO



OVALE 29007-1 99

Art.	Ø/mm
● -G	60
● -S	60
● -B	60
○ -w	60

B-S-G: RETRO MEDAGLIA NERO LUCIDO
NESSUN MINIMO D'ORDINE RICHIESTO





90008-1 50 mm

Art.	HxL/mm
● -1B	140x90
● -1S	140x90
● -1G	140x90

DISCO NON INCLUSO



90009-1 50 mm

Art.	HxL/mm
● -1B	140x90
● -1S	140x90
● -1G	140x90

DISCO NON INCLUSO



90010-1 50 mm

Art.	HxL/mm
● -1B	140x90
● -1S	140x90
● -1G	140x90

DISCO NON INCLUSO

ABBINA IL TROFEO CON LA MEDAGLIA

Personalizza la tua premiazione

SERIE PORTADISCO

90008-90009-90010 Trofeo
29008- 29009 - 29010 Medaglia

MATERIALE METACRILATO SPESSORE 3 mm
QUATTRO COLORI
Oro. Argento. Bronzo FINITURA METALLO



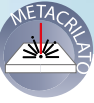

29008-1 50 mm

Art.	Ø/mm
● -1G	70
● -1S	70
● -1B	70

DISCO NON INCLUSO
B-S-G: RETRO MEDAGLIA NERO LUCIDO



29009-1 25 mm 33 mm

Art.	Ø/mm
● -1G	60
● -1S	60
● -1B	60

DISCO NON INCLUSO
B-S-G: RETRO MEDAGLIA NERO LUCIDO

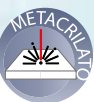

29010-1 25 mm 33 mm

Art.	Ø/mm
● -1G	60
● -1S	60
● -1B	60

DISCO NON INCLUSO
B-S-G: RETRO MEDAGLIA NERO LUCIDO



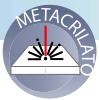

29011 25 mm

Art.	Ø/mm
● -1G	70
● -1S	70
● -1B	70

DISCO NON INCLUSO
B-S-G: RETRO MEDAGLIA NERO LUCIDO

DISCIPLINE

Possibilità di sviluppare
QUALSIASI disciplina.

29012 25 mm

Art.	Ø/mm
● -1G	60
● -1S	60
● -1B	60

DISCO NON INCLUSO
B-S-G: RETRO MEDAGLIA NERO LUCIDO



● 90600-2

● 90600-3

● 90600-1

BEST
seller

90600

H/mm	Targhetta
125	100x20

AREA BASE
DISCO Ø 50 mm





VERSIONE MEDAGLIA
100 X 60 mm



90604

H/mm Targhetta
110 50x17

DISCIPLINE

Specificare nell'ordine il codice.
Possibilità di sviluppare
QUALSIASI disciplina.



-911



-261



-151



-211



-311



-191



-171



-201



-031



-321



BEST
seller

90605

VETRO

Art.	H/mm	L/mm
-1	95	100
-2	125	130
-3	135	150

Soggetto non incluso ME1 PAG. 16



● 90606-1S



● 90606-1G



● 90606-1B



90606 ⁵⁰/_{mm}

H/mm Targhetta

125 50x17
Disco non incluso



PERSONALIZZAZIONE

SCEGLI IL DISCO DA 70 mm
IMMAGINI VEDI PAG. 16



90608 50 mm

H/mm Targhetta
175 50x17
Disco non incluso



● 90607-1B

● 90607-1G

● 90607-1B

90607 50 mm

H/mm Targhetta
150 50x17
Disco non incluso

PLASTICA
ABS

MARMO



90609 50 mm

H/mm Targhetta

150 50x17
Disco non incluso



90611 50 mm

H/mm Targhetta

175 50x17
Disco non incluso



90610 50 mm

H/mm Targhetta

175 50x17
Disco non incluso



90612 50 mm

H/mm Targhetta

175 50x17
Disco non incluso



90613 50 mm
 H/mm Targhetta

185 50x17
 Disco non incluso



● 90613-1S

● 90613-1G

● 90613-1B



● 90614-1S

● 90614-1G

● 90614-1B



90614 50 mm
 H/mm Targhetta

185 50x17
 Disco non incluso



90615

70 mm

Art.	H/mm	Targhetta
-1	165	50x17

Applicazione o disco incluso



-341



-031



-161



-151



-981



-111



-112



-241



-023



-191



-321



-641



-061



-021



-331



-301



-912



-051



-171



-221



-302



-371



-231



-201



-022

ODINARE 90615-1 + COD. SOGGETTO

VERSIONE CON DISCO BIANCO SUBLIMATICO DA 70 MM INCLUSO ORDINARE

90615-1 911 - porta disco 1

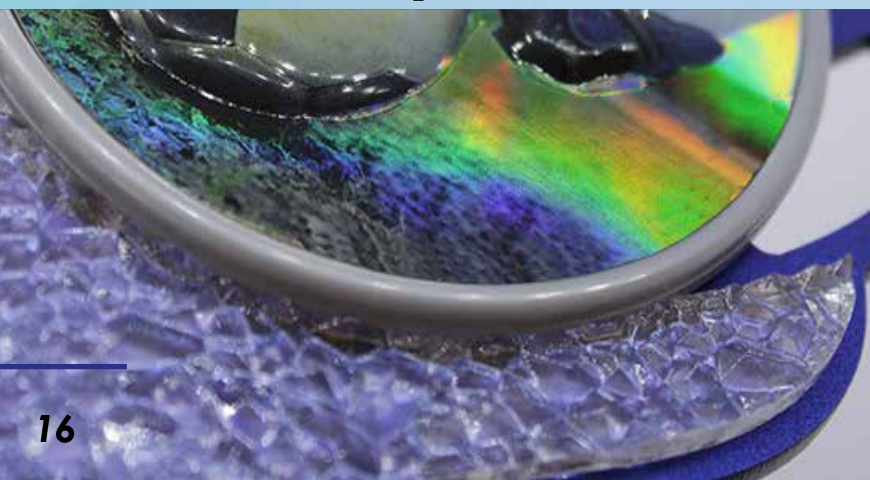

ME1 70 mm

Art.	Ø/mm
ME1	70



-261



-032



-222



-431



-291



-141



-262



RP8114

Art. mm

RP8114 50-70
Applicazione non inclusa

90616

70
mm

Art. H/mm Targhetta

-1 185 50x17

Applicazione o disco incluso



ORDINARE 90616-1 + COD. SOGGETTO

VERSIONE CON DISCO BIANCO SUBLIMATICO
DA 70 MM INCLUSO ORDINARE

90616-1 911 - porta disco 1





90621

25 mm

Art.	H/mm	Targhetta
------	------	-----------

-1	140	50x17
-2	165	50x25
-3	180	50x25

Disco non incluso



90625

50 mm

Art.	H/mm	Targhetta
------	------	-----------

-1	245	50x25
----	-----	-------

Disco non incluso



● 90623-1S

● 90623-1B

● 90623-1G

90623 25 mm

H/mm	Targhetta
------	-----------

150	50x17
-----	-------

Disco non incluso



90624

25 mm

BEST seller

XXL size

Art.	H/mm	Targhetta
-1	230	50x17
-2	255	50x17
-3	280	50x17

Disco non incluso



XXL size

90622

25 mm

Art.	H/mm	Targhetta
-1	180	50x25
-2	200	50x25
-3	220	50x25



90626



Art.	H/mm	Targhetta
-1	165	50x25
-2	185	50x25
-3	210	50x25

Disco non incluso



90627



Art.	H/mm	Targhetta
-1	195	60x25
-2	220	60x25
-3	245	70x25

Disco non incluso



90628

Art.	H/mm	Targhetta
-1	170	50x25
-2	195	60x25

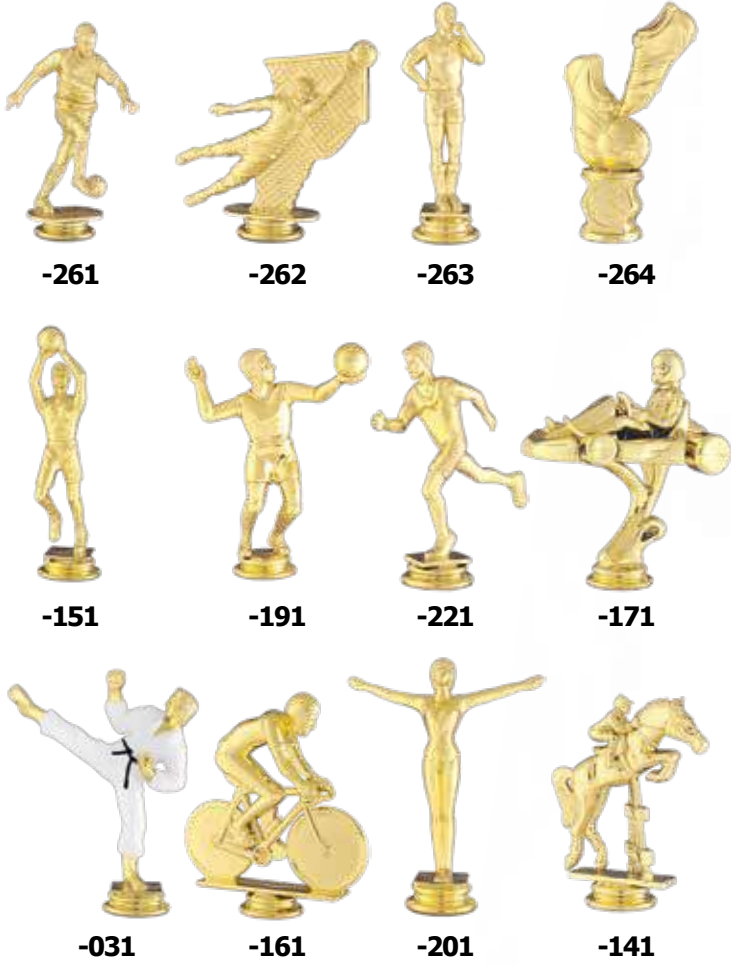

-261

-262

-263

-264

-151

-191

-221

-171

-031

-161

-201

-141



-912



-911



90629



Art.	H/mm	Targhetta
-1	150	50x25
-2	170	60x25
-3	205	70x25



-031



-141



-151



-161



-171



-191



-221



-281



90630

Art.	H/mm	Targhetta
-031	165	50x17
-141	130	50x17
-151	175	50x17
-161	160	50x17
-171	160	50x17
-191	155	50x17
-221	160	50x17
-261	160	50x17
-262	140	50x17
-263	160	50x17
-264	180	50x17
-281	165	50x17
-911	215	50x17
-921	225	50x25



-911



-921



-261



-262



-263



-264



90631 

H/mm Targhetta
185 50x25



90632

H/mm Targhetta
145 50x25



PLASTICA
ABS

MARMO



90633

H/mm Targhetta

180 50x25



90634

H/mm Targhetta

165 50x25



90635

H/mm Targhetta

170 50x25



90636-261



90636-262



90636-263

90636

H/mm Targhetta

110 50x17



 50mm PORTADISCO

90637

H/mm Targhetta

100 50x17

90640

H/mm Targhetta

160 50x25





90638-261



90638-262

90638

H/mm	Targhetta
115	50x17



90639

H/mm	Targhetta
125	50x17

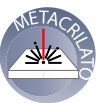

90641

H/mm	Targhetta
155	50x25



VARIANTI

NESSUN MINIMO D'ORDINE RICHIESTO

Specificare nell'ordine il codice figura.

90643

H/mm Targhetta

155 50x25



-1 MP1



-1 MA1



-1 MG1



-1 PD1



-1 FP1



-1 CC1

PERSONALIZZA

- Scegli lo stile
- Scegli i colori del tuo team (Tutti i colori possono essere rappresentati)
- **NESSUN MINIMO D'ORDINE RICHIESTO**
- **COSTI PER REALIZZAZIONE IMPIANTO**
MESSA IN MACCHINA
ELABORAZIONE GRAFICA A PROGETTO



-FIG 1



-FIG 2



-FIG 3



-FIG 4



-FIG 5



-FIG 6

90642

H/mm Targhetta

165 50x25



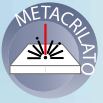

90644-1

H/mm Targhetta

155 50x25

DISCIPLINE

Specificare nell'ordine il codice.
 Possibilità di sviluppare
 QUALSIASI disciplina.



-011



-031



-061



-101



-151



-161



-191



-201



-221



-231



-241



-261



-271



-321



-911



90645

Art.	H/mm	Targhetta
-1	140	50x25
-2	155	50x25
-3	175	50x25

DISCIPLINE

Specificare nell'ordine il codice.
 Possibilità di sviluppare
 QUALSIASI disciplina.



-061

-101

-111

-151

-161

-171

-191

-201

-221

-231

-241

-261

-271

-911

25 mm

TROFEI PARTECIPAZIONE
 ACRYCOLOR - STAMPA IN ALTA DEFINIZIONE
 IL TROFEO CON LO SPORT CHE AMI



90646

Art.	H/mm	Targhetta
-1	160	50x25
-2	180	50x25
-3	200	50x25

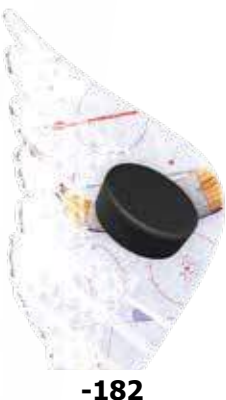

DISCIPLINE

Specificare nell'ordine il codice.
 Possibilità di sviluppare
 QUALSIASI disciplina.



-99

VERSIONE -99 LOGO

PERSONALIZZATA

- NESSUN MINIMO D'ORDINE RICHIESTO
- COSTI PER MESSA IN MACCHINA
- ELABORAZIONE GRAFICA A PROGETTO

TROFEI PARTECIPAZIONE
ACRICOLORE - STAMPA IN ALTA DEFINIZIONE
IL TROFEO CON LO SPORT CHE AMI



90647



Art.	H/mm	Targhetta
-1	160	50x25
-2	180	50x25
-3	200	50x25



-201



-221



-151



-261

DISCIPLINE

Specificare nell'ordine il codice.
Possibilità di sviluppare
QUALSIASI disciplina.

VERSIONE -99 LOGO

PERSONALIZZATA

- **NESSUN MINIMO D'ORDINE RICHIESTO**
- **COSTI PER MESSA IN MACCHINA**
ELABORAZIONE GRAFICA A PROGETTO



-191

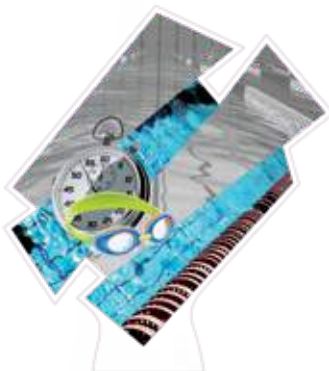

-241



-321



-171



-031



-101



-99

TROFEI PARTECIPAZIONE
 ACRYCOLOR - STAMPA IN ALTA DEFINIZIONE
 IL TROFEO CON LO SPORT CHE AMI



● 90648-1S

● 90648-1G

● 90648-1B

TRIOLOGY
90648
 H/mm Targhetta
 180 50x25

DISCIPLINE

Specificare nell'ordine il codice.
 Possibilità di sviluppare
 QUALSIASI disciplina

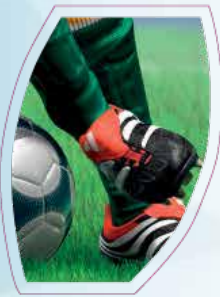

-261



-201



-111



-141



-171



-151



-231



-021



-001



-911



-051



-101



-271



-221



-031



VERSIONE UV

PERSONALIZZATA

- **NESSUN MINIMO D'ORDINE RICHIESTO**
- COSTI PER REALIZZAZIONE IMPIANTO
 MESSA IN MACCHINA
 ELABORAZIONE GRAFICA A PROGETTO

90649UV

Art.	H/mm	Targhetta
-1	225	60X25
-2	250	60X25
-3	275	60X25



90649

Art.	H/mm	Targhetta
-1	225	60X25
-2	250	60X25
-3	275	60X25

Disco non incluso



DISCIPLINE

Specificare nell'ordine il codice.
Possibilità di sviluppare
QUALSIASI disciplina



90651

Art. H/mm

-1	110x70
-2	140x100

Cristallo Spessore 20 mm
Stampa quadricromia inclusa

VERSIONE -99 LOGO

PERSONALIZZATA

- **NESSUN MINIMO D'ORDINE RICHIESTO**
- **COSTI PER MESSA IN MACCHINA**
- **ELABORAZIONE GRAFICA A PROGETTO**



-221



-231



-201



-261



4° TROFEO
RC luce CE.AS.CAR.

-99



-151



-191



90652

Art.	H/mm	L/mm
-1	130	60
-2	150	60
-3	170	60

Cristallo Spessore 20 mm
Stampa quadricromia inclusa



-99

VERSIONE -99 LOGO

PERSONALIZZATA

- **NESSUN MINIMO D'ORDINE RICHIESTO**
- **COSTI PER MESSA IN MACCHINA**
ELABORAZIONE GRAFICA A PROGETTO



-241



-171



-161



-031



-491



-911



90653

Art.	H/mm	Ø/mm
-1	130	100
-2	150	120
-3	170	140
-4	190	160

Cristallo Spessore 20 mm
Stampa quadricromia inclusa

VERSIONE -99

PERSONALIZZATA

- **NESSUN MINIMO D'ORDINE RICHIESTO**
- **COSTI PER MESSA IN MACCHINA ELABORAZIONE GRAFICA A PROGETTO**

DISCIPLINE

Specificare nell'ordine il codice.
Possibilità di sviluppare
QUALSIASI disciplina.



-99



-031



-231



-151



-141



-241



-191



-271



-221



-111



-261



-161



-491



-201

DISCIPLINE

Specificare nell'ordine il codice.
Possibilità di sviluppare
QUALSIASI disciplina.



-FP1



-MA1



-PD1



-MP1



-MG1



-CC1



90655

Art.	H/mm	Targhetta
-1	240	70x25
-2	270	70x25
-3	300	70x25

CALCIO SERIE TORNADO



TROFEO ASSEMBLATO CON PALLONE IN METALLO ED INSERTO IN METACRILATO EFFETTO METALLICO.





BEST
seller

90528

Art.	H/mm	Targhetta
-1	260	70x25
-2	285	70x25
-3	305	70x35

90528-1

SCEGLI TRA SEI VARIANTI DISPONIBILI PER
PREMIARE IL TUO TORNEO
Specificare nell'ordine il codice.



90528-1 CC1



90528-1 MG1



90528-1 MP1

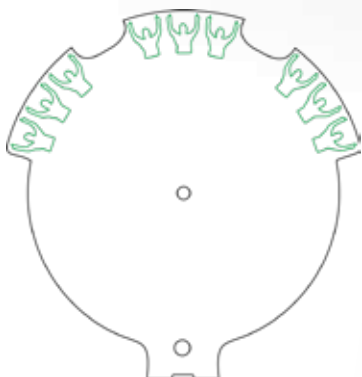

90528-1 000
NEUTRO



90528-1 FP1



90528-1 MA1

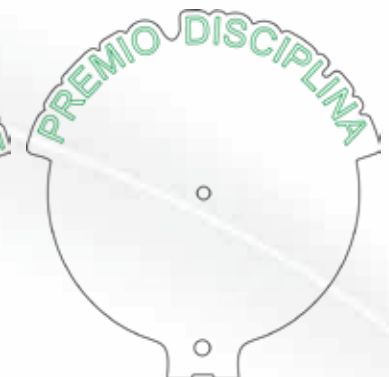

90528-1 PD1



BEST seller **90658** 
H/mm Targhetta
190 50x17



BEST seller **90657** 
H/mm Targhetta
190 50x17



BEST
seller

90659

25
mm

Art.	H/mm	Targhetta
-1	180	50X17
-2	200	50X17
-3	220	60X25



DETTAGLIO
RETRO





90660



H/mm Targhetta
150 50x17



90661



H/mm Targhetta
155 50x17



90662

H/mm	Targhetta
290	60x25



90663

H/mm	Targhetta
255	60x25



90664



Art.	H/mm	Targhetta
-1	240	70x25
-2	260	70x25
-3	300	70x25



90666

H/mm Targhetta
240 50x25



90665

H/mm Targhetta
620 110x50





90667

H/mm	Targhetta
245	60x25



90668

H/mm	Targhetta
220	60x25



90669

H/mm	Targhetta
220	60x25



90670

H/mm	Targhetta
190	60x25



90671

H/mm	Targhetta
150	60x25



90673 Taglio Laser

Trofeo in metacrilato trasparente 6 mm.
 Figure in metacrilato argento su sfondo
 nero.
 Base in legno color ciliegio.

SCATOLA DI PRESENTAZIONE
INCLUSA



90673

Art.	H/mm	L/mm
------	------	------

-1	220	320
----	-----	-----

Spessore 6 mm



APPLICAZIONE ME1

Disco da 70 mm non incluso
Vedi Pag. 16



90674



Art.	H/mm	Targhetta
-1	245	70x25
-2	280	70x25
-3	320	70x25

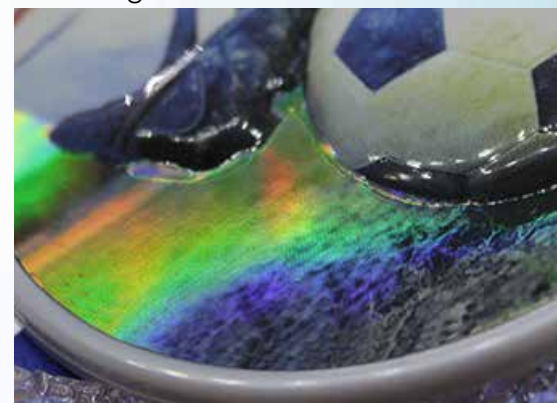

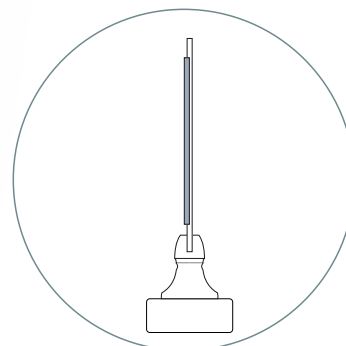

DETTAGLIO
 PROFILO



**90675 METACRILATO
 NEUTRO**

Art.	H/mm	Targhetta
-1	350	70x25
-2	370	70x25
-3	390	70x35



**90675-99 METACRILATO
 PERSONALIZZATO**

Art.	H/mm	Targhetta
-1	350	70x25
-2	370	70x25
-3	390	70x35

NESSUN MINIMO D'ORDINE RICHIESTO

- COSTI PER MESSA IN MACCHINA
 ELABORAZIONE GRAFICA A PROGETTO

SU RICHIESTA È POSSIBILE APPLICARE SUL
 SUPPORTO IN ACRILICO LA TARGA IN
 ALLUMINIO ARGENTO SPAZZOLATO

Art.
T13S-255100



Esempio di
 personalizzazione
 con targa di alluminio applicata



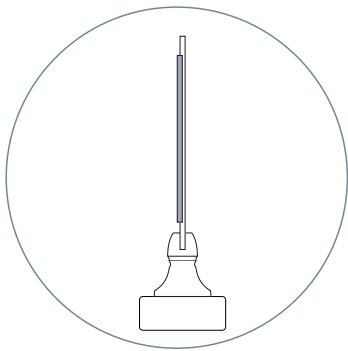

DETTAGLIO
 PROFILO



**90676 METACRILATO
 NEUTRO**

Art.	H/mm	Targhetta
-1	350	70x25
-2	370	70x25
-3	390	70x35



**90676-99 METACRILATO
 PERSONALIZZATO**

Art.	H/mm	Targhetta
-1	350	70x25
-2	370	70x25
-3	390	70x35

NESSUN MINIMO D'ORDINE RICHIESTO

- COSTI PER MESSA IN MACCHINA
 ELABORAZIONE GRAFICA A PROGETTO

SU RICHIESTA È POSSIBILE APPLICARE SUL
 SUPPORTO IN ACRILICO LA TARGA IN
 ALLUMINIO ARGENTO SPAZZOLATO

Art.
T14S-250120



Esempio di
 personalizzazione
 con targa di alluminio applicata



90677 METACRILATO NEUTRO

Art.	H/mm	Targhetta
-1	255	70x25
-2	280	70x25
-3	305	70x25
-4	345	70x35



90677-99 METACRILATO PERSONALIZZATO

Art.	H/mm	Targhetta
-1	255	70x25
-2	280	70x25
-3	305	70x25
-4	345	70x35

NESSUN MINIMO D'ORDINE RICHIESTO

- COSTI PER MESSA IN MACCHINA
ELABORAZIONE GRAFICA A PROGETTO

SU RICHIESTA É POSSIBILE APPLICARE SUL SUPPORTO IN ACRILICO LA TARGA IN ALLUMINIO ARGENTO SPAZZOLATO

Art.

-1-2 T16S-16085

-3-4 T16S-175100

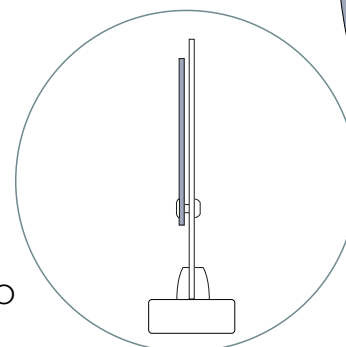

DETTAGLIO
PROFILO



Esempio di personalizzazione con targa di alluminio applicata



90678 METACRILATO NEUTRO

Art.	H/mm	Targhetta
-1	310	50x25
-2	345	60x25
-3	395	70x35
-4	440	80x35



90678-99 METACRILATO PERSONALIZZATO

Art.	H/mm	Targhetta
-1	310	50x25
-2	345	60x25
-3	395	70x35
-4	440	80x35

NESSUN MINIMO D'ORDINE RICHIESTO

- COSTI PER MESSA IN MACCHINA
 ELABORAZIONE GRAFICA A PROGETTO

SU RICHIESTA É POSSIBILE APPLICARE SUL SUPPORTO IN ACRILICO LA TARGA IN ALLUMINIO ARGENTO SPAZZOLATO

Art.

-1-2 T16S-16085

-3-4 T16S-175100

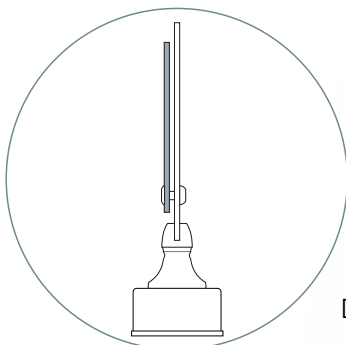

DETTAGLIO PROFILO

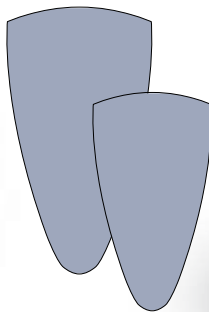

Esempio di personalizzazione con targa di alluminio applicata



90679 METACRILATO NEUTRO

Art.	H/mm	Targhetta
-1	255	70x25
-2	280	70x25
-3	350	70x25
-4	345	70x35



90679-99 METACRILATO PERSONALIZZATO

Art.	H/mm	Targhetta
-1	255	70x25
-2	280	70x25
-3	350	70x25
-4	345	70x35

NESSUN MINIMO D'ORDINE RICHIESTO

- COSTI PER MESSA IN MACCHINA
 ELABORAZIONE GRAFICA A PROGETTO

SU RICHIESTA É POSSIBILE APPLICARE SUL SUPPORTO IN ACRILICO LA TARGA IN ALLUMINIO ARGENTO SPAZZOLATO

Art.

-1-2 T15S-170105

-3-4 T15S-205125

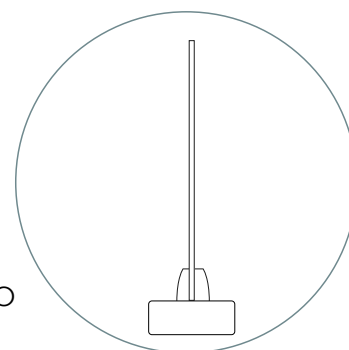

DETTAGLIO PROFILO



Esempio di personalizzazione con targa di alluminio applicata



90680 METACRILATO NEUTRO

Art.	H/mm	Targhetta
-1	310	50x25
-2	345	60x25
-3	395	70x35
-4	440	80x35



90680-99 METACRILATO PERSONALIZZATO

Art.	H/mm	Targhetta
-1	310	50x25
-2	345	60x25
-3	395	70x35
-4	440	80x35

NESSUN MINIMO D'ORDINE RICHIESTO

- COSTI PER MESSA IN MACCHINA
ELABORAZIONE GRAFICA A PROGETTO

SU RICHIESTA È POSSIBILE APPLICARE SUL
SUPPORTO IN ACRILICO LA TARGA IN
ALLUMINIO ARGENTO SPAZZOLATO

Art.

-1-2 T15S-170105

-3-4 T15S-205125

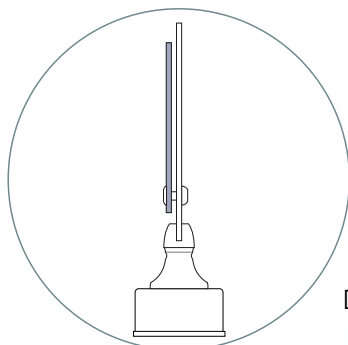

DETTAGLIO
PROFILO

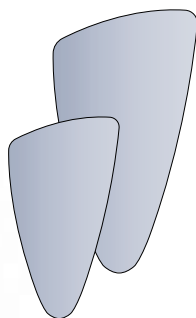

Esempio di
personalizzazione
con targa di alluminio applicata

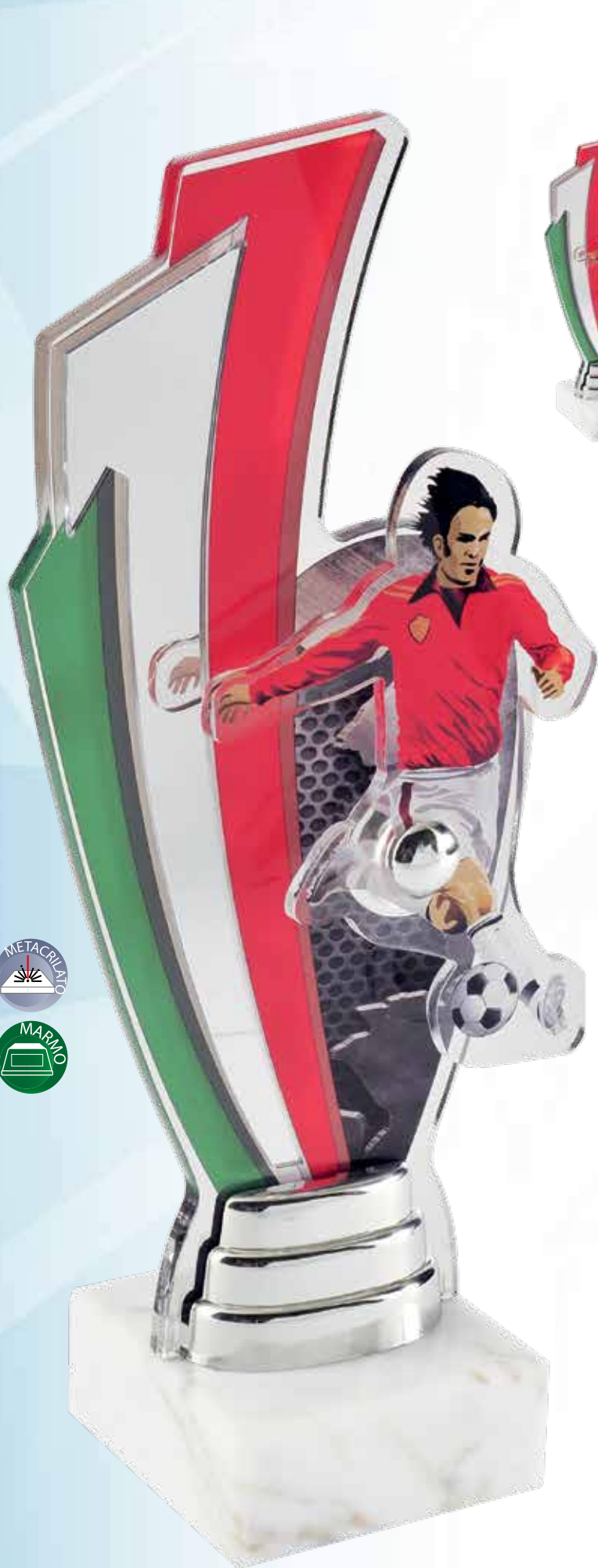

90681

Art.	H/mm	Targhetta
-1	260	70x25
-2	285	70x25
-3	310	70x25
-4	345	70x35

PREMI INDIVIDUALI

Calcio



-261



-262



-263

DISCIPLINE

Specificare nell'ordine il codice.
 Possibilità di sviluppare
 QUALSIASI disciplina



-011



-021



-031



-241



-071



-101

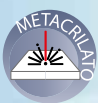



90681-911

70 mm

Art.	H/mm	Disco	Targhetta
-1	260	70	70x25
-2	285	70	70x25
-3	310	70	70x25
-4	345	70	70x35

DISCO 70 MM - Non Incluso

Disco in alluminio sublimatico bianco
Venduto separatamente.
VEDI Pag. 199



-264



-172



-421



-151



-171



-191



-221



-99



VERSIONE -99

PERSONALIZZATA

- **NESSUN MINIMO D'ORDINE RICHIESTO**
- COSTI PER REALIZZAZIONE IMPIANTO
MESSA IN MACCHINA ED
ELABORAZIONE GRAFICA A PROGETTO

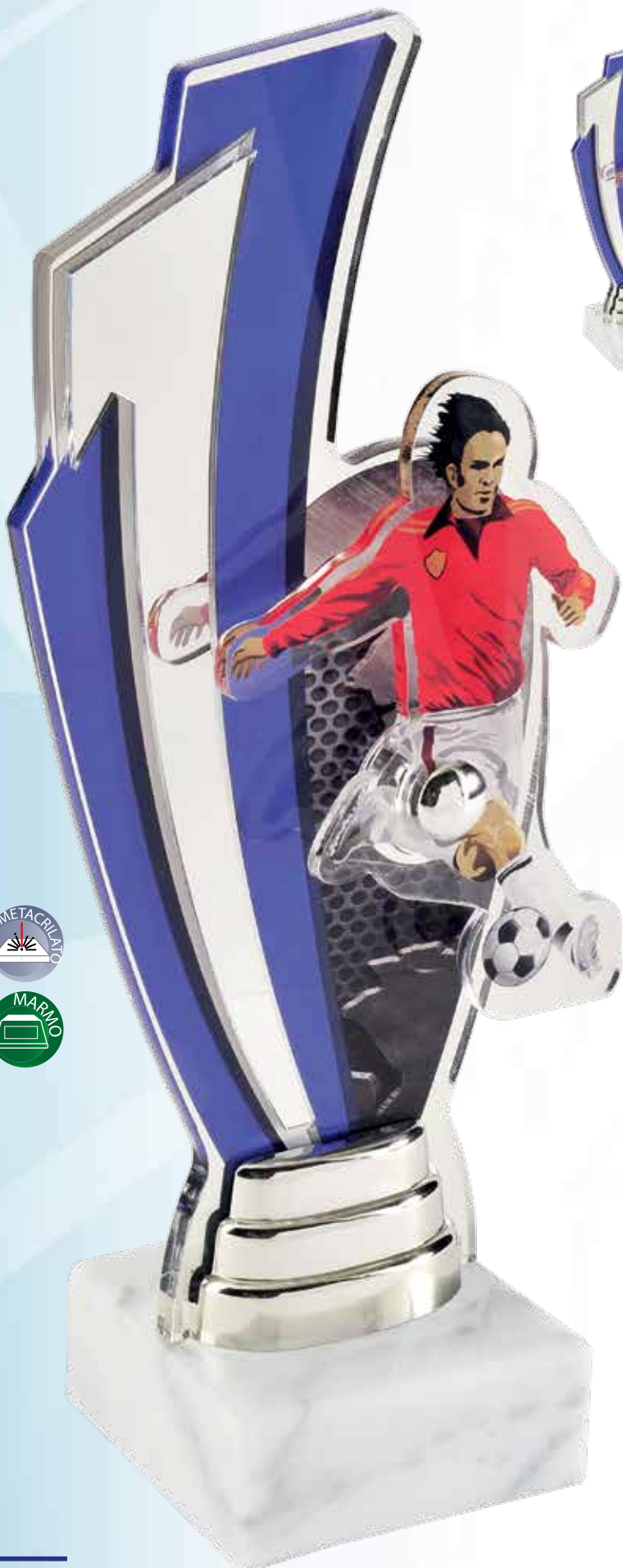

INCLUSA STAMPA HD

90682

Art.	H/mm	Targhetta
-1	260	70x25
-2	285	70x25
-3	310	70x25
-4	345	70x35

PREMI INDIVIDUALI

Calcio



-261



-262



-263

DISCIPLINE

Specificare nell'ordine il codice.
 Possibilità di sviluppare
 QUALSIASI disciplina



-011



-021



-031



-241

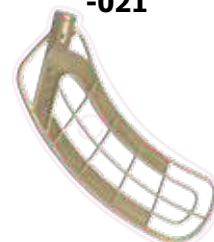

-071



-101





90682-911

70 mm

Art.	H/mm	Disco	Targhetta
-1	260	70	70x25
-2	285	70	70x25
-3	310	70	70x25
-4	345	70	70x35

DISCO 70 MM - Non Incluso

Disco in alluminio sublimatico bianco
Venduto separatamente.
VEDI Pag. 199



-264



-172



-421



-151



-171



-191



-221



-99



VERSIONE -99

PERSONALIZZATA

- **NESSUN MINIMO D'ORDINE RICHIESTO**
- **COSTI PER REALIZZAZIONE IMPIANTO MESSA IN MACCHINA ED ELABORAZIONE GRAFICA A PROGETTO**

TROFEI CONVENIENZA
 ACRYCOLOR - STAMPA IN ALTA DEFINIZIONE
 SCEGLI LO SPORT CHE AMI



INSERTO IN METACRILATO ARGENTO SPECCHIATO



STAMPA HD **90683**

Art.	H/mm	Targhetta
-1	305	50x25
-2	345	60x25
-3	385	70x35
-4	445	80x25

DISCIPLINE

Specificare nell'ordine il codice.
 Possibilità di sviluppare
 QUALSIASI disciplina

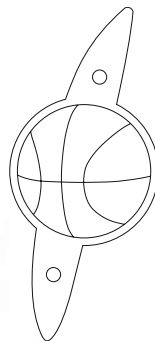

-151

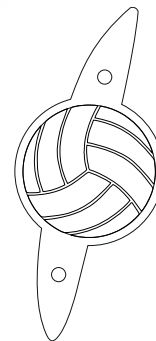

-191

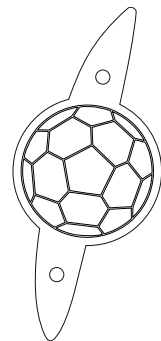

-261

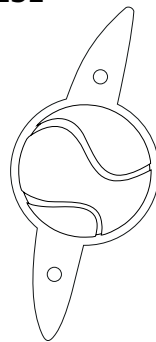

-201

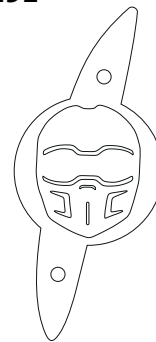

-171

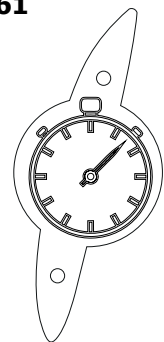

-221



INSERTO IN METACRILATO ARGENTO SPECCHIATO



90683-911

Art.	H/mm	Disco	Targhetta
-1	305	70	50x25
-2	345	70	60x25
-3	385	70	70x35
-4	445	70	80x25

DISCO - Non Incluso

Disco in alluminio sublimatico bianco
 Venduto separatamente.
 VEDI Pag. 199



VERSIONE -99

PERSONALIZZATA

- **NESSUN MINIMO D'ORDINE RICHIESTO**
- **COSTI PER REALIZZAZIONE IMPIANTO**
 MESSA IN MACCHINA ED
 ELABORAZIONE GRAFICA A PROGETTO



TROFEI CONVENIENZA
 ACRYCOLOR - STAMPA IN ALTA DEFINIZIONE
 SCEGLI LO SPORT CHE AMI



INSERTO IN METACRILATO ARGENTO SPECCHIATO



90684

Art.	H/mm	Targhetta
-1	305	70x25
-2	345	70x25
-3	385	70x25
-4	445	70x25



DISCIPLINE

Specificare nell'ordine il codice.
 Possibilità di sviluppare
 QUALSIASI disciplina

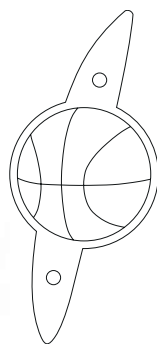

-151

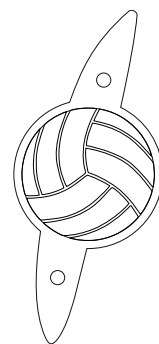

-191

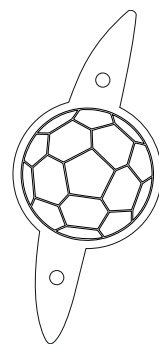

-261

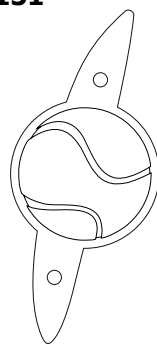

-201

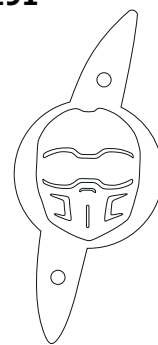

-171

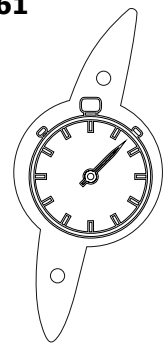

-221

INSERTO IN METACRILATO ARGENTO SPECCHIATO



90684-911

Art.	H/mm	Disco	Targhetta
-1	305	70	50x25
-2	345	70	65x35
-3	385	70	70x35
-4	445	70	80x25

DISCO - Non Incluso

Disco in alluminio sublimatico bianco
Venduto separatamente.
VEDI Pag. 199



VERSIONE -99

PERSONALIZZATA

- **NESSUN MINIMO D'ORDINE RICHIESTO**
- **COSTI PER REALIZZAZIONE IMPIANTO MESSA IN MACCHINA ED ELABORAZIONE GRAFICA A PROGETTO**



DISCIPLINE

Specificare nell'ordine il codice.
 Possibilità di sviluppare
 QUALSIASI disciplina



90685B BRONZO

Art.	H/mm	Targhetta
-1	240	70x25
-2	270	70x25
-3	300	70x25



-191



-171



-081



90685S ARGENTO

Art.	H/mm	Targhetta
-1	240	70x25
-2	270	70x25
-3	300	70x25



-261



-911



-031



-321



90685G ORO

Art.	H/mm	Targhetta
-1	240	70x25
-2	270	70x25
-3	300	70x25

VERSIONE -99

PERSONALIZZATA

- NESSUN MINIMO D'ORDINE RICHIESTO
- COSTI PER REALIZZAZIONE IMPIANTO MESSA IN MACCHINA ED ELABORAZIONE GRAFICA A PROGETTO

TROFEI CONVENIENZA
 ACRYCOLOR - STAMPA IN ALTA DEFINIZIONE
 IL TROFEO PERSONALIZZABILE



-221



-201



-271



-301



-151



-262



-263



-241



-111



TRILOGY
 Serie consigliata

Art.	H/mm	Targhetta
● 90685-1B	240	70x25
● 90685-2S	270	70x25
● 90685-3G	300	70x25

PREMI INDIVIDUALI

Calcio



90686

Art.	H/mm	Targhetta
-1	250	70x25
-2	275	70x25
-3	300	70x25



-262



-261



-263



DISCIPLINE

Specificare nell'ordine il codice.
 Possibilità di sviluppare
 QUALSIASI disciplina



-151



-191



-201



TROFEI CONVENIENZA
 ACRYCOLOR - STAMPA IN ALTA DEFINIZIONE
 IL TROFEO PERSONALIZZABILE



-051



-241



-421



-251



-021



-981



-321



-411



-101



-031



-011



-171



-172



-173



-161



90687

Art.	H/mm	Targhetta
-1	360	60x25
-2	410	70x35
-3	460	80x35
-4	510	90x40



DISCIPLINE

Specificare nell'ordine il codice.
 Possibilità di sviluppare
 QUALSIASI disciplina



-173



-151



-191



-261



-161

Vista dall'alto

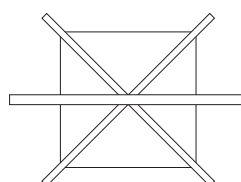





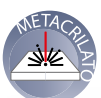

VERSIONE -99

PERSONALIZZATA

- **NESSUN MINIMO D'ORDINE RICHIESTO**
- **COSTI PER REALIZZAZIONE IMPIANTO**
- **MESSA IN MACCHINA ED ELABORAZIONE GRAFICA A PROGETTO**



90687-91

	Art.	H/mm	Targhetta
 90 mm	 -1	360	60x25
 110 mm	 -2	410	70x35
 110 mm	 -3	460	80x35



DISCO - Non Incluso

Disco in alluminio sublimatico bianco
 Venduto separatamente.
 VEDI Pag. 199





**METACRILATO
PERSONALIZZATO
90689-99**

Art.	H/mm
-1	230
-2	250
-3	270

VERSIONE -99

PERSONALIZZATA

- **NESSUN MINIMO D'ORDINE RICHIESTO**
- COSTI PER REALIZZAZIONE IMPIANTO, MESSA IN MACCHINA ED, ELABORAZIONE GRAFICA A PROGETTO

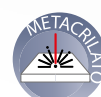

90688

Art.	H/mm	Targhetta
-1	270	60x25
-2	320	70x35
-3	370	80x35



**METACRILATO
PERSONALIZZATO
90688-99**

Art.	H/mm
-1	270
-2	320
-3	370

VERSIONE -99

PERSONALIZZATA

- **NESSUN MINIMO D'ORDINE RICHIESTO**
- COSTI PER REALIZZAZIONE IMPIANTO MESSA IN MACCHINA ED ELABORAZIONE GRAFICA A PROGETTO

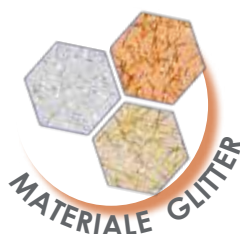

Esempio di personalizzazione

**SPECIFICARE NELL'ORDINE
IL CODICE REGIONE**

Art.	REGIONE
01	Abruzzo
02	Basilicata
03	Calabria
04	Campania
05	Emilia-Romagna
06	Friuli-Venezia Giulia
07	Lazio
08	Liguria
09	Lombardia
10	Marche
11	Molise
12	Piemonte
13	Puglia
14	Sardegna
15	Sicilia
16	Toscana
17	Trentino-Alto Adige
18	Umbria
19	Valle d'Aosta
20	Veneto



90690 NEUTRA

Art.	H/mm	Targhetta
-1	270	60x25
-2	300	70x35
-3	330	70x35



METACRILATO PERSONALIZZATO 90690-99

Art.	H/mm
-1	270
-2	300
-3	330



90689 NEUTRA

Art.	H/mm	Targhetta
-1	230	70x25
-2	250	70x25
-3	270	70x25

VERSIONE -99

PERSONALIZZATA

- **NESSUN MINIMO D'ORDINE RICHIESTO**
- COSTI PER REALIZZAZIONE IMPIANTO
MESSA IN MACCHINA ED
ELABORAZIONE GRAFICA A PROGETTO

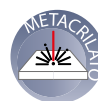



90100

BEST
seller

Art.	H/mm	Targhetta
-1	205	50x17
-2	220	50x17
-3	240	50x25



90101

Art.	H/mm	Targhetta
-1	110	50x25
-2	130	50x25
-3	145	60x25
-4	165	70x25



Coppe partecipazione
in ABS
Vedi Pag. 18-20



90103

Art.	H/mm	Targhetta
-1	135	50x25
-2	160	50x25
-3	190	60x25
-4	210	70x25



90104

50 mm

Art.	H/mm	Targhetta
-1	210	50x25
-2	225	50x25
-3	240	60x25
-4	270	70x25

Disco non incluso



90105

50 mm

**BEST
seller**

Art.	H/mm	Targhetta
-1	215	50x25
-2	230	50x25
-3	245	60x25
-4	275	70x25

Disco non incluso



BORDO SMUSSATO

MARMO



BORDO SMUSSATO

MARMO



90106

50 mm

Art.	H/mm	Targhetta
-1	210	50x25
-2	235	50x25
-3	270	60x25
-4	305	70x25



90108

Art.	H/mm	Targhetta
-1	225	50x17
-2	240	50x25
-3	260	60x25
-4	290	60x25



90109

Art.	H/mm	Targhetta
-1	210	50x25
-2	225	50x25
-3	255	60x25
-4	290	70x25



90110

25 mm

Art.	H/mm	Targhetta
-1	235	60x25
-2	255	70x25
-3	275	70x25



PERSONALIZZATA

90110UV



Art.	H/mm	Targhetta
-1	235	60x25
-2	255	70x25
-3	275	70x25

VERSIONE UV

PERSONALIZZATA

- **NESSUN MINIMO D'ORDINE RICHIESTO**
- COSTI PER REALIZZAZIONE IMPIANTO MESSA IN MACCHINA ED ELABORAZIONE GRAFICA A PROGETTO



90111

50 mm

BEST
seller

Art.	H/mm	Targhetta
-1	235	50x25
-2	255	50x25
-3	270	60x25
-4	290	60x25

Disco non incluso



BORDO SMUSSATO

MARMO



BORDO SMUSSATO

MARMO



90114

Art.	H/mm	Targhetta
-1	245	50x25
-2	270	60x25
-3	300	70x25

TRILOGY
Serie consigliata

25
mm

Art.	H/mm	Targhetta
● 90115-1	305	60x25
● 90116-2	325	60x25
● 90117-3	345	70x25





25
mm

90117

ORO

Art.	H/mm	Targhetta
-1	305	60x25
-2	325	60x25
-3	345	70x25



25
mm

90116

ARGENTO

Art.	H/mm	Targhetta
-1	305	60x25
-2	325	60x25
-3	345	70x25



25
mm

90115

BRONZO

Art.	H/mm	Targhetta
-1	305	60x25
-2	325	60x25
-3	345	70x25



PLASTICA
ABS

MARMO



90118

BEST
seller

Art.	H/mm	Targhetta
-1	270	50x17
-2	300	60x25
-3	345	60x25



90119

25
mm

Art.	H/mm	Targhetta
-1	305	60x25
-2	325	60x25
-3	345	70x25



25 mm

90120

BLU



Art.	H/mm	Targhetta
-1	330	50x25
-2	350	60x25
-3	370	70x25



25 mm

90121

ORO



Art.	H/mm	Targhetta
-1	330	50x25
-2	350	60x25
-3	370	70x25





90122

Art.	H/mm	Targhetta
-1	340	60x25
-2	355	60x25
-3	370	70x25



90123



Art.	H/mm	Targhetta
-1	370	60x25
-2	390	60x25
-3	410	70x25





90125

Art.	H/mm	Targhetta
-1	305	60x25
-2	320	60x25
-3	335	70x25





90203

50 mm

BLU

Art.	H/mm	Targhetta
-1	375	50x25
-2	395	50x25
-3	410	60x25

DISPONIBILE DA FINE APRILE 2019



90204 TRILOGY

Art.	H/mm	Targhetta
-1	260	60x25
-2	305	70x25
-3	340	70x35



90205 ARGENTO



Art.	H/mm	Targhetta
-1	240	50x25
-2	270	50x55
-3	295	60x25
-4	320	70x25
-5	365	70x25



90206 ORO



Art.	H/mm	Targhetta
-1	225	50x25
-2	265	50x55
-3	305	60x25
-4	335	70x25
-5	365	70x25





50 mm

90210 ARGENTO

Art.	H/mm	Targhetta
-1	240	50x25
-2	255	50x25
-3	270	60x25
-4	290	70x25
-5	320	70x35
-6	355	70x35

Disco non incluso



50 mm

90211 ARGENTO

BEST seller

Art.	H/mm	Targhetta
-1	235	50x25
-2	260	60x25
-3	280	60x25
-4	300	70x25
-5	325	70x35
-6	355	80x35

Disco non incluso



25 mm

90212 ARGENTO

XXL size

Art.	H/mm	Targhetta
-1	255	50x25
-2	280	60x25
-3	315	60x25
-4	345	70x25
-5	390	70x35



25 mm

90213 ORO

Art.	H/mm	Targhetta
-1	255	50x25
-2	280	60x25
-3	315	60x25
-4	345	70x25
-5	390	70x35



BORDO SMUSSATO

MARMO





90214

Mariner

25 mm

Art.	H/mm	Targhetta
-1	250	50x25
-2	295	60x25
-3	315	60x25
-4	340	70x25
-5	375	70x35
-6	410	80x35



90215

Daytona

25 mm

Art.	H/mm	Targhetta
-1	250	50x25
-2	295	60x25
-3	315	60x25
-4	340	70x25
-5	375	70x35
-6	410	80x35



90216

Forest

25 mm

Art.	H/mm	Targhetta
-1	250	50x25
-2	295	60x25
-3	315	60x25
-4	340	70x25
-5	375	70x35
-6	410	80x35



90217

25 mm

Art.	H/mm	Targhetta
-1	260	50x25
-2	300	60x25
-3	325	70x25
-4	365	70x25
-5	400	80x35



90218

25 mm

Art.	H/mm	Targhetta
-1	260	50x25
-2	300	60x25
-3	325	70x25
-4	365	70x25
-5	400	80x35



90219 TRICOLORE



Art.	H/mm	Targhetta
-1	260	50x25
-2	285	60x25
-3	315	60x25
-4	345	70x35
-5	375	70x35
-6	395	80x35





90220 *Mariner*

Art.	H/mm	Targhetta
-1	265	50x25
-2	295	60x25
-3	310	60x25
-4	335	70x25
-5	380	70x35
-6	405	70x35



90221 *Forest*

Art.	H/mm	Targhetta
-1	265	50x25
-2	295	60x25
-3	310	60x25
-4	335	70x25
-5	380	70x35
-6	405	70x35



90222 *Daytona*



Art.	H/mm	Targhetta
-1	265	50x25
-2	295	60x25
-3	310	60x25
-4	335	70x25
-5	380	70x35
-6	405	70x35



90223 *Marilyn*



Art.	H/mm	Targhetta
-1	265	50x25
-2	295	60x25
-3	310	60x25
-4	335	70x25
-5	380	70x35
-6	405	70x35



DISCIPLINE

Specificare nell'ordine il codice.
Possibilità di sviluppare
QUALSIASI disciplina

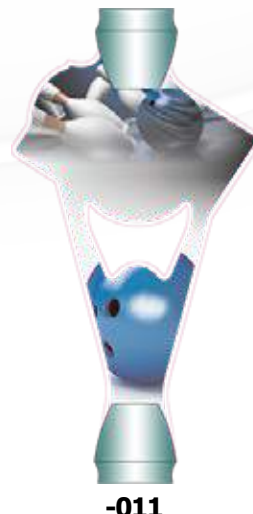
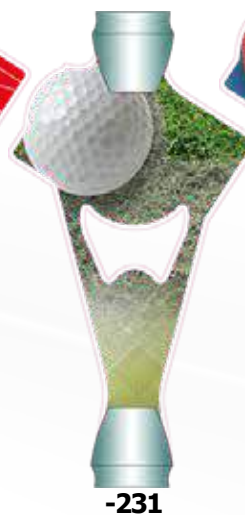
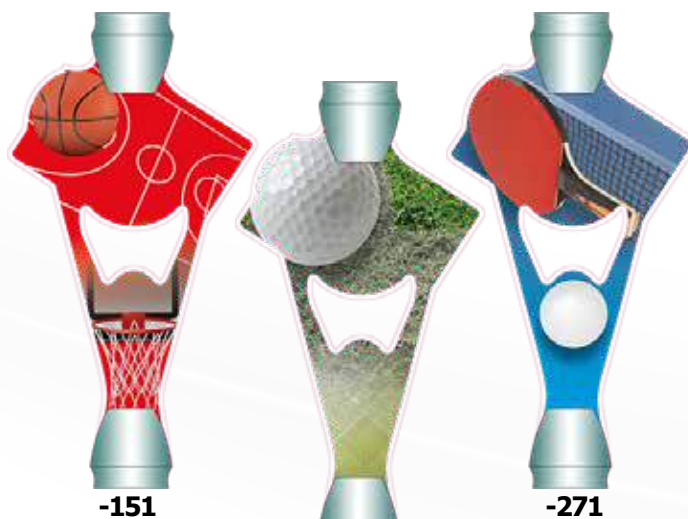

90224

Art.	H/mm	Targhetta
-1	280	60x25
-2	295	60x25
-3	360	70x25
-4	395	70x35

POSSIBILITÀ DI SVILUPPARE
QUALSIASI DISCIPLINA

VERSIONE -UV

PERSONALIZZATA

- **NESSUN MINIMO D'ORDINE RICHIESTO**
- **COSTI PER REALIZZAZIONE IMPIANTO
MESSA IN MACCHINA ED
ELABORAZIONE GRAFICA A PROGETTO**



PERSONALIZZATA

90224UV

Art.	H/mm	Targhetta
-1	280	60x25
-2	295	60x25
-3	360	70x25
-4	395	70x35

NESSUN MINIMO D'ORDINE RICHIESTO





TRILOGY
Serie consigliata



Art.	H/mm	Targhetta
● 90300-2	310	70x35
● 90301-3	355	80x35
● 90302-4	400	90x40



90302 ORO

Art.	H/mm	Targhetta
-2	310	70x25
-3	355	70x35
-4	400	80x35



90301 ARGENTO

Art.	H/mm	Targhetta
-1	280	65x25
-2	310	70x25
-3	355	70x35
-4	400	80x35



90300 BRONZO

Art.	H/mm	Targhetta
-1	280	65x25
-2	310	70x25
-3	355	70x35
-4	400	80x35



90303

25 mm

Art.	H/mm	Targhetta
-1	235	60x25
-2	250	60x25
-3	290	70x25
-4	330	70x35
-5	365	80x35



90304

25 mm

Art.	H/mm	Targhetta
-1	225	50x25
-2	240	50x25
-3	265	60x25
-4	305	70x25
-5	335	70x35
-6	375	80x35



90305

25 mm

Art.	H/mm	Targhetta
-1	215	60x25
-2	235	60x25
-3	270	70x25
-4	310	70x25
-5	350	70x35
-6	400	80x35



90306

25 mm

Art.	H/mm	Targhetta
-1	240	50x25
-2	275	60x25
-3	330	70x25
-4	350	70x35
-5	395	80x35





90307

50 mm

Art.	H/mm	Targhetta
-1	235	50x25
-2	260	60x25
-3	290	70x25
-4	325	70x35
-5	350	80x35



90308

50 mm

Art.	H/mm	Targhetta
-1	235	50x25
-2	260	60x25
-3	290	70x25
-4	325	70x35
-5	350	80x35



90309

25 mm

Art.	H/mm	Targhetta
-1	300	50x25
-2	335	60x25
-3	370	70x25
-4	395	70x35
-5	435	80x35



90310

Art.	H/mm	Targhetta
-1	330	60x25
-2	360	70x25
-3	410	70x35
-4	440	80x35





90311

BEST
seller

XXL
size

Art.	H/mm	Targhetta
-1	275	60x25
-2	300	70x25
-3	330	70x25
-4	375	70x35
-5	415	80x35

BOHDO SMUSSATO

MARMO



90312

25
mm

BEST
seller

XXL
size

Art.	H/mm	Targhetta
-1	290	60x25
-2	335	60x25
-3	360	70x25
-4	370	70x35
-5	415	80x35



90313

BEST
seller

XXL
size

Art.	H/mm	Targhetta
-1	330	70x25
-2	360	70x35
-3	400	80x35



90314

BEST
seller

XXL
size

Art.	H/mm	Targhetta
-1	280	60x25
-2	310	70x25
-3	345	70x35
-4	385	70x35
-5	420	80x35



BORDO SMUSATO

MARMO



TRILOGY
Serie consigliata



Art.	H/mm	Targhetta
90315-2	360	65x25
90316-3	410	70x35
90317-4	440	80x35



H 465



90317



Art.	H/mm	Targhetta
-2	360	60x25
-3	410	70x35
-4	440	80x35
-5	465	90x40



90316



Art.	H/mm	Targhetta
-1	330	50x25
-2	360	60x25
-3	410	70x35
-4	440	80x35



90315



Art.	H/mm	Targhetta
-1	330	50x25
-2	360	60x25
-3	410	70x35
-4	440	80x35



90318

25 mm



Art.	H/mm	Targhetta
-1	280	60x25
-2	305	70x25
-3	350	70x35
-4	420	80x35
-5	470	90x40



90319

25 mm



Art.	H/mm	Targhetta
-1	290	70x25
-2	320	70x25
-3	365	70x35
-4	405	80x35
-5	450	90x40





90320



Art.	H/mm	Targhetta
-1	290	60x25
-2	335	70x25
-3	380	70x35
-4	425	80x35
-5	480	90x40



90321



Art.	H/mm	Targhetta
-1	325	70x25
-2	350	70x35
-3	400	80x35
-4	440	80x35
-5	475	90x40





TRILOGY
Serie consigliata



Art.	H/mm	Targhetta
● 90322-2	415	70x35
● 90323-3	435	80x35
● 90324-4	475	90x40



H 475



90324

ORO

Art.	H/mm	Targhetta
-1	360	60x25
-2	415	70x35
-3	435	80x35
-4	475	90x40



90323

ARGENTO

Art.	H/mm	Targhetta
-1	360	65x25
-2	415	70x35
-3	435	80x35



90322

BRONZO

Art.	H/mm	Targhetta
-1	360	60x25
-2	415	70x35
-3	435	80x35

DISCIPLINE

Specificare nell'ordine il codice.
Possibilità di sviluppare
QUALSIASI disciplina

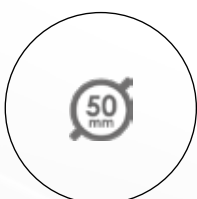

-911



-171



-201



-261



-241



-191



-151



90325

Art.	H/mm	Targhetta
-1	345	50x25
-2	375	60x25
-3	405	70x35
-4	445	80x35

Disco non incluso
POSSIBILITÀ DI SVILUPPARE
QUALSIASI DISCIPLINA



PERSONALIZZATA
90325UV

Art.	H/mm	Targhetta
-1	345	50x25
-2	375	60x25
-3	405	70x35
-4	445	80x35

VERSIONE UV

PERSONALIZZATA

- **NESSUN MINIMO D'ORDINE RICHIESTO**
- COSTI PER REALIZZAZIONE IMPIANTO
MESSA IN MACCHINA ED
ELABORAZIONE GRAFICA A PROGETTO





90326

25 mm



Art.	H/mm	Targhetta
-1	285	70x25
-2	335	70x25
-3	355	70x35
-4	405	80x35
-5	440	90x40



90327

25 mm



Art.	H/mm	Targhetta
-1	320	50x25
-2	355	60x25
-3	410	70x35
-4	475	80x35





90328

25 mm

**BEST
seller**

Art.	H/mm	Targhetta
-1	270	50x25
-2	300	50x25
-3	340	60x25
-4	395	70x35
-5	430	80x35
-6	470	90x40



90329

25 mm

Art.	H/mm	Targhetta
-1	300	50x25
-2	340	60x25
-3	385	70x35
-4	425	80x35
-5	470	90x40





90330

25 mm

Art.	H/mm	Targhetta
-1	300	50x25
-2	355	60x25
-3	420	70x35
-4	475	80x35



90331

XXL size

Art.	H/mm	Targhetta
-1	360	60x25
-2	400	70x35
-3	450	80x55
-4	505	90x40





90332

Art.	H/mm	Targhetta
-1	360	50x25
-2	410	60x25
-3	440	70x35
-4	500	80x35



90333

Art.	H/mm	Targhetta
-1	340	50x25
-2	380	60x25
-3	430	70x35
-4	495	80x35



90334

BEST
seller

Art.	H/mm	Targhetta
-1	365	50x25
-2	410	60x25
-3	435	70x35
-4	485	80x35



90335

25
mm

XXL
size

Art.	H/mm	Targhetta
-1	300	50x25
-2	360	60x25
-3	415	70x35
-4	485	80x35
-5	515	90x40





90336

25 mm

Art.	H/mm	Targhetta
-1	320	50x25
-2	365	60x25
-3	405	70x35
-4	460	80x35
-5	500	90x40



90337

25 mm

Art.	H/mm	Targhetta
-1	350	60x25
-2	405	70x35
-3	455	80x35
-4	480	90x40



90339



Art.	H/mm	Targhetta
-1	430	60x25
-2	490	70x35
-3	545	80x35



90338



Art.	H/mm	Targhetta
-1	490	70x35
-2	540	80x35
-3	610	90x40





Vista dall'alto

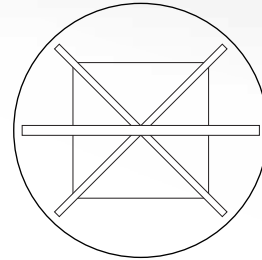

Metacrilato glitter argento
Base in ABS

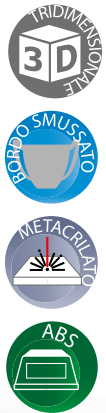

90340

Art.	H/mm	Targhetta
-1	370	60x25
-2	405	70x35
-3	450	80x35
-4	500	90x40





90401 TRILOGY

Art.	H/mm	Targhetta
-1	120	60x25
-2	145	70x25
-3	165	70x35
-4	180	80x35



90402

Art.	H/mm	Targhetta
-1	95	50x25
-2	115	60x25
-3	125	70x25
-4	155	70x35
-5	175	80x35
-6	205	90x40





BEST
seller

90400

Art.	H/mm	Targhetta
-1	160	50x25
-2	180	50x25
-3	210	60x25
-4	225	60x25
-5	260	70x35

DISPONIBILE DA FINE APRILE 2019



BEST
seller

90403

Art.	H/mm	Targhetta
-1	130	50x25
-2	140	50x25
-3	160	60x25
-4	180	70x35
-5	205	80x35



90404

Art.	H/mm	Targhetta
-1	135	50x25
-2	150	50x25
-3	180	60x25
-4	200	60x25
-5	220	70x35



90405

Art.	H/mm	Targhetta
-1	165	50x25
-2	180	60x25
-3	200	60x25
-4	220	70x35
-5	245	80x35





90406 TRILOGY

Art.	H/mm	Targhetta
-1	185	70x25
-2	205	70x35
-3	225	70x35
-4	255	80x35



90407

**BEST
seller**

Art.	H/mm	Targhetta
-1	175	70x25
-2	190	70x35
-3	210	70x55
-4	230	70x35
-5	255	80x35





90408 TRICOLORE

Art.	H/mm	Targhetta
-1	205	70x25
-2	230	70x25
-3	255	70x35
-4	290	80x35



90410

Art.	H/mm	Targhetta
-1	235	60x25
-2	275	70x35
-3	300	80x35
-4	330	90x40





90409

Art.	H/mm	Targhetta
-1	190	50x25
-2	215	50x25
-3	235	60x25
-4	260	70x35
-5	300	80x35



90409CC

Art.	H/mm	Targhetta
-2CC	310	50x25
-3CC	345	60x25
-4CC	380	70x35
-5CC	430	80x35





90411 TRILOGY

Art.	H/mm	Targhetta
-1	295	60x25
-2	325	70x35
-3	360	80x35





90412

Art.	H/mm	Targhetta
-1	215	50x25
-2	255	60x25
-3	295	70x35
-4	315	80x35
-5	360	90x40



90412-99 PERSONALIZZATA

Art.	H/mm	Targhetta
-2	255	60x25
-3	295	70x35
-4	315	80x35
-5	360	90x40

VERSIONE -99

PERSONALIZZATA

- **NESSUN MINIMO D'ORDINE RICHIESTO**
MESSA IN MACCHINA ED
ELABORAZIONE GRAFICA A PROGETTO





BEST
seller

90413CC



Art.	H/mm	Targhetta
-1CC	400	60x25
-2CC	450	70x35
-3CC	500	80x35
-4CC	550	90x40



BEST
seller

90413

Art.	H/mm	Targhetta
-1	300	60x25
-2	335	70x35
-3	375	80x35
-4	415	90x40





90415

Art.	H/mm	Targhetta
-1	340	60x25
-2	395	70x35
-3	440	80x35
-4	500	90x40



90414



Art.	H/mm	Targhetta
-1	265	50x25
-2	300	60x25
-3	340	70x35
-4	380	80x35
-5	420	90x40





90416CC

Art.	H/mm	Targhetta
-1CC	510	80x35
-2CC	545	90x40
-3CC	630	110x50



90416



Art.	H/mm	Targhetta
-1	405	80x35
-2	450	90x40
-3	505	110x50





90417CC 

Art.	H/mm	Targhetta
-1CC	425	60x25
-2CC	485	70x35
-3CC	530	80x35
-4CC	570	90x40
-5CC	635	110x50



90417

Art.	H/mm	Targhetta
-1	345	60x25
-2	380	70x35
-3	420	80x35
-4	465	90x40
-5	500	110x50





90418CC



Art.	H/mm	Targhetta
-1CC	530	80x35
-2CC	590	90x40
-3CC	660	110x50



90418

Art.	H/mm	Targhetta
-1	425	80x35
-2	475	90x40
-3	525	110x50





90419 TRILOGY

Art.	H/mm	Targhetta
-1	425	80x35
-2	470	90x40
-3	530	110x50



TRILOGY 90419CC



Art.	H/mm	Targhetta
-1CC	530	80x35
-2CC	580	90x40
-3CC	660	110x50



90420

Art.	H/mm	Targhetta
-1	400	70x35
-2	450	80x35
-3	500	90x40



90421CC

Art.	H/mm	Targhetta
-1CC	455	80x35
-2CC	505	80x35
-3CC	550	90x40





90423

70 mm

Art.	H/mm	Targhetta
-1	450	80x35
-2	495	90x40
-3	545	110x50

Disco non incluso



90422

XXL size

Art.	H/mm	Targhetta
-1	475	80x35
-2	540	90x40
-3	605	110x50



90425CC

Art.	H/mm	Targhetta
-1CC	460	70x35
-2CC	520	80x35
-3CC	580	90x40
-4CC	660	110x50



90424 ORO

Art.	H/mm	Targhetta
-1	370	70x35
-2	420	80x35
-3	450	90x40
-4	530	110x50



90425

Art.	H/mm	Targhetta
-1	370	70x35
-2	420	80x35
-3	450	90x40
-4	530	110x50



90426

Art.	H/mm	Targhetta
-1	450	90x40
-2	520	110x50
-3	570	110x50



90427



Art.	H/mm	Targhetta
-1	415	70x35
-2	470	80x35
-3	520	90x40
-4	570	110x50
-5	612	110x50



90428

Art.	H/mm	Targhetta
-1	280	60x25
-2	330	70x35
-3	380	90x40
-4	450	110x50



90429

Art.	H/mm	Targhetta
-1	440	90x40
-2	480	110x50
-3	520	110x50
-4	570	110x50
-5	610	110x50



90430CC

Art.	H/mm	Targhetta
-1CC	520	90x40
-2CC	550	110x50
-3CC	660	110x50
-4CC	720	110x50



90430



Art.	H/mm	Targhetta
-1	405	90x40
-2	445	110x50
-3	520	110x50
-4	565	110x50



90431



Art.	H/mm	Targhetta
-1	350	80x35
-2	390	90x40
-3	440	110x50
-4	480	110x50
-5	530	110x50



90431CC

Art.	H/mm	Targhetta
-2CC	500	90x40
-3CC	560	110x50
-4CC	600	110x50
-5CC	660	110x50



90432CC

Art.	H/mm	Targhetta
-2CC	590	90x40
-3CC	625	110x50
-4CC	675	110x50
-5CC	700	110x50



90432



Art.	H/mm	Targhetta
-1	400	90x40
-2	470	110x50
-3	510	110x50
-4	550	110x50
-5	580	110x50





90433

Art.	H/mm	Targhetta
-1	720	110x50
-2	800	110x50
-3	860	110x50





BEST
seller

90501

Art.	H/mm	Targhetta
-1	380	70x25
-2	435	80x35
-3	500	90x40



90500

Art.	H/mm	Targhetta
-1	380	70x25
-2	435	80x35
-3	500	90x40





90502

Art.	H/mm	Targhetta
-1	370	70x25
-2	425	80x35
-3	490	90x40



90503

Art.	H/mm	Targhetta
-1	390	70x35
-2	435	80x35
-3	500	90x40



BEST
seller

TRIOLOGY
90505

70
mm

Art.	H/mm	Targhetta
-1	385	60x25
-2	420	70x25
-3	460	80x35

Disco non incluso





90508

50
mm

Art.	H/mm	Targhetta
-1	440	60x25
-2	470	70x35
-3	500	80x35

Disco non incluso



90504

Art.	H/mm	Targhetta
-1	390	70x35
-2	435	80x35
-3	500	90x40



90506

Art.	H/mm	Targhetta
-1	410	60x25
-2	445	70x35
-3	515	80x35



BEST
seller

90507 TRILOGY

Art.	H/mm	Targhetta
-1	405	60x25
-2	460	70x35
-3	505	80x35





-261



-262



-263



-264



-151



-191



-141



-161



-171



-021



-231



-201



-911



-912



90509

Art.	H/mm	Targhetta
-1	430	60x25
-2	455	70x35
-3	490	80x35





90510 METACRILATO NEUTRO

Art.	H/mm	Targhetta
-1	430	60x25
-2	455	70x35
-3	490	80x35



90510-99 METACRILATO PERSONALIZZATO

Art.	H/mm	Targhetta
-1	430	60x25
-2	455	70x35
-3	490	80x35

NESSUN MINIMO D'ORDINE RICHIESTO

- COSTI PER MESSA IN MACCHINA
ELABORAZIONE GRAFICA A PROGETTO



SU RICHIESTA É POSSIBILE APPLICARE SUL SUPPORTO IN ACRILICO LA TARGA IN ALLUMINIO ARGENTO SPAZZOLATO

Art.

T12S-24590



Esempio di personalizzazione



90511 METACRILATO NEUTRO

Art.	H/mm	Targhetta
-1	430	60x25
-2	455	70x35
-3	480	80x35



90511-99 METACRILATO PERSONALIZZATO

Art.	H/mm	Targhetta
-1	430	60x25
-2	455	70x35
-3	490	80x35

NESSUN MINIMO D'ORDINE RICHIESTO

- COSTI PER MESSA IN MACCHINA
ELABORAZIONE GRAFICA A PROGETTO

SU RICHIESTA È POSSIBILE APPLICARE SUL SUPPORTO IN ACRILICO LA TARGA IN ALLUMINIO ARGENTO SPAZZOLATO

Art.
T13S-255100



Esempio di personalizzazione





90512 METACRILATO NEUTRO

Art.	H/mm	Targhetta
-1	420	70x35
-2	455	80x35
-3	470	90x40



90512-99 METACRILATO PERSONALIZZATO

Art.	H/mm	Targhetta
-1	420	70x35
-2	455	80x35
-3	470	90x40

NESSUN MINIMO D'ORDINE RICHIESTO

- COSTI PER MESSA IN MACCHINA
ELABORAZIONE GRAFICA A PROGETTO



SU RICHIESTA É POSSIBILE APPLICARE SUL SUPPORTO IN ACRILICO LA TARGA IN ALLUMINIO ARGENTO SPAZZOLATO

Art.
T14S-250120



Esempio di personalizzazione

90513

Art.	H/mm	Targhetta
-1	400	70x35
-2	440	80x35
-3	490	90x40





-261



-262



-263



-264



-151



-191



-141



-161



-171



-031



-221



-201



-911



-912



90515

Art.	H/mm	Targhetta
-1	400	70x35
-2	440	80x35
-3	490	90x40



**BEST
seller**

90516 TRILOGY

Art.	H/mm	Targhetta
-1	415	70x35
-2	485	80x35
-3	540	90x40





90517

Art.	H/mm	Targhetta
-1	465	70x35
-2	520	80x35
-3	565	90x40



90518

Art.	H/mm	Targhetta
-1	465	70x35
-2	520	80x35
-3	565	90x40





90519 TRILOGY

Art.	H/mm	Targhetta
-1	470	70x35
-2	520	80x35
-3	580	90x40



PORTADISCO



90520 CON PORTADISCO

Art.	H/mm	Targhetta
-1	470	80x35
-2	520	90x40
-3	570	110x50



90520UV

Art.	H/mm	Targhetta
-1	470	80x35
-2	520	90x40
-3	570	110x50

VERSIONE UV

PERSONALIZZATA

- **NESSUN MINIMO D'ORDINE RICHIESTO**
- **COSTI PER REALIZZAZIONE IMPIANTO**
MESSA IN MACCHINA ED
ELABORAZIONE GRAFICA A PROGETTO





-261

-262

-263

-264

-151

-191

-141

-161

-171

-031

-221

-201

-911

-912



90521



Art.	H/mm	Targhetta
-1	475	80x35
-2	520	90x40
-3	590	110x50



90523

Art.	H/mm	Targhetta
-1	650	110x50
-2	695	110x50
-3	735	110x50





90527 PALLONE

Art.	H/mm	Targhetta
-1	395	60x25
-2	450	70x35
-3	490	80x35
-4	545	90x40



90525 PALLONE 50 mm

Art.	H/mm
-1	550
-2	610
-3	670

Disco non incluso



90524 TAZZA 50 mm

Art.	H/mm
-1	520
-2	575
-3	630

Disco non incluso



CALCIO SERIE TORNADO

TROFEO ASSEMBLATO CON PALLONE IN METALLO ED INSERTO IN METACRILATO EFFETTO METALLICO.

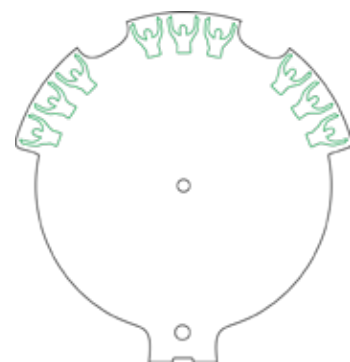

**BEST
seller**

90528

Art.	H/mm	Targhetta
-1	260	70x25
-2	285	70x25
-3	305	70x35

90528-1 000
NEUTRO





90528

Art.	H/mm	Targhetta
-1	345	70x25

SCEGLI TRA SEI VARIANTI DISPONIBILI
PER PREMIARE IL TUO TORNEO
Specificare nell'ordine il codice.

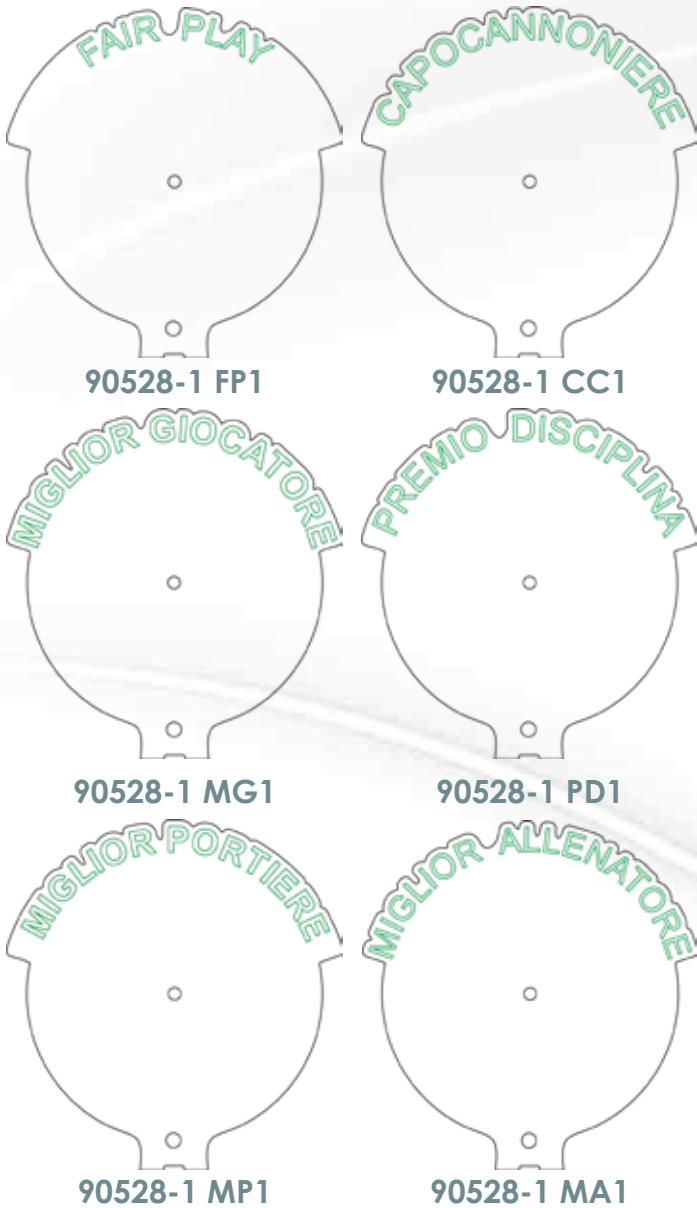

90529

Art.	H/mm	Targhetta
-1	230	50x25
-2	260	60x25
-3	290	70x35
-4	320	80x35

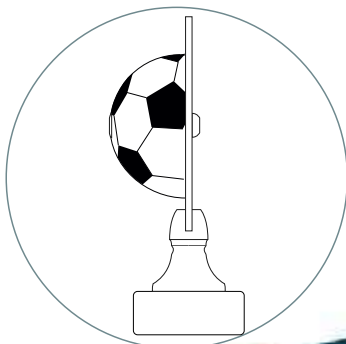

DETTAGLIO
PROFILO TORNADO



CALCIO
SERIE TORNADO



DETTAGLIO
PROFILO TORNADO



90530 NEUTRO

Art.	H/mm	Targhetta
-1	280	70x35
-2	320	80x35
-3	370	90x40

Specificare nell'ordine il codice.



90530-1 FP1



90530-1 PD1



90530-1 MA1



90530-1 MG1



90530-1 MP1



90530-1 CC1

90530

Art.	H/mm	Targhetta
-1	380	70x35



90531 TRILOGY
CALCIO

Art.	H/mm	Targhetta
-1	420	70x35
-2	460	80x35
-3	500	90x40

90533 TRILOGY
PALLAVOLO

Art.	H/mm	Targhetta
-1	420	70x35
-2	460	80x35
-3	500	90x40





90534 TRILOGY
CALCIO

Art.	H/mm	Targhetta
-1	500	80x35
-2	540	90x40
-3	610	110x50



90532 TRILOGY
BASKET

Art.	H/mm	Targhetta
-1	420	70x35
-2	460	80x35
-3	500	90x40



LINEA TROFEO CRISTALLO

TROFEO VETRO CON SCATOLA



SPESSORE 4 MM



90700

Art.	HxL/mm
-1	180 x 180
-2	190 x 190
-3	210 x 210

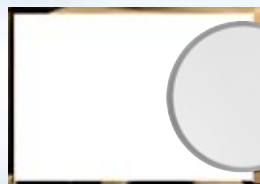

TARGHE in ALLUMINIO
Vedi Pag. 195-199



90605

a Pag. 12

TROFEO VETRO CON SCATOLA



SPESSORE 4 MM



90701

Art.	HxL/mm
-1	165 x 120
-2	185 x 130
-3	205 x 140



90702

Art.	HxL/mm
-1	170 x 140
-2	190 x 150
-3	210 x 160



SPESSORE 8 MM

TARGHE in ALLUMINIO
Vedi Pag. 195-199



90703

Art.	HxL/mm
-1	190 x 110
-2	205 x 120
-3	230 x 130

TROFEO VETRO CON SCATOLA



SPESSORE 8 MM

LINEA TROFEO CRISTALLO

TROFEO CRISTALLO CON SCATOLA NEUTRO O STAMPATO



SPESSORE 20 MM



90652

Art.	HxL/mm
-1	130 x 60
-2	150 x 60
-3	170 x 60



90652-99 CON LOGO STAMPATO

Art.	HxL/mm
-1	130 x 60
-2	150 x 60
-3	170 x 60

PERSONALIZZAZIONE VERSIONE - 99

- NESSUN MINIMO D'ORDINE RICHIESTO
- COSTI PER REALIZZAZIONE IMPIANTO MESSA IN MACCHINA ELABORAZIONE GRAFICA A PROGETTO

TROFEO CRISTALLO CON SCATOLA NEUTRO O STAMPATO



SPESSORE 6 MM



90653

Art.	HxL/mm
-1	130 x 100
-2	150 x 120
-3	170 x 140
-4	190 x 160



90653-99 CON LOGO STAMPATO

Art.	HxL/mm
-1	130 x 100
-2	150 x 120
-3	170 x 140
-4	190 x 160

TROFEO CRISTALLO CON SCATOLA NEUTRO O STAMPATO



90704

Art.	HxL/mm
-1	120 x 80
-2	150 x 100
-3	180 x 120



90704-99 CON LOGO STAMPATO

Art.	HxL/mm
-1	120 x 80
-2	150 x 100
-3	180 x 120



TARGHE in ALLUMINIO
Vedi Pag. 195-199



TROFEO CRISTALLO CON ASTUCCIO NEUTRO



90707

Art.	HxL/mm
-1	115 x 100
-2	135 x 120
-3	155 x 140
-4	180 x 160
-5	220 x 200



LINEA TROFEO CRISTALLO

FERMACARTE CON ASTUCCIO NEUTRO O STAMPATO



SPESSORE 30 MM

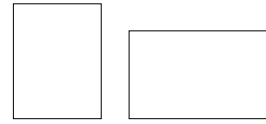

90709

Art.	HxL/mm
-1	80 x 50
-2	150 x 50



90709-99 CON LOGO STAMPATO

Art.	HxL/mm
-1	80 x 50
-2	150 x 50

PERSONALIZZAZIONE VERSIONE - 99

- NESSUN MINIMO D'ORDINE RICHIESTO
- COSTI PER REALIZZAZIONE IMPIANTO
MESSA IN MACCHINA
ELABORAZIONE GRAFICA A PROGETTO



TROFEO CRISTALLO CON ASTUCCIO NEUTRO O STAMPATO



SPESSORE 20 MM



90651

Art.	LxH/mm
-1	105x65
-2	140x100



90651-99 CON LOGO STAMPATO

Art.	LxH/mm
-1	105x65
-2	140x100

LINEA TROFEO CRISTALLO

LENTE FERMACARTE CON ASTUCCIO NEUTRO O STAMPATO



90710

Art. ø/mm

-1 80

SPESSORE 40 mm



90710-99 CON LOGO STAMPATO

Art. ø/mm

-1 80



**PERSONALIZZAZIONE
VERSIONE - 99**

- NESSUN MINIMO D'ORDINE RICHIESTO
- COSTI PER REALIZZAZIONE IMPIANTO MESSA IN MACCHINA ELABORAZIONE GRAFICA A PROGETTO

TROFEO CRISTALLO CON ASTUCCIO NEUTRO O STAMPATO



90711

Art. LxH/mm

-1 70 x 75

-2 90 x 95

-3 110 x 115

-4 130 x 135

SPESSORE 20 mm



90711-99 CON LOGO STAMPATO

Art. LxH/mm

-1 70 x 75

-2 90 x 95

-3 110 x 115

-4 130 x 135



SPESSORE 20 MM

LINEA TROFEO CRISTALLO

TROFEO CRISTALLO FONDO BIANCO SUBLIMATICO, CON ASTUCCIO

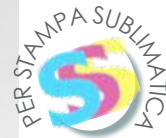

90713

Art.	LxH/mm
-1	100 x 140
-2	120 x 170
-3	140 x 190

PER STAMPA SUBLIMATICA
FONDO BIANCO

SPESSORE 20 MM



TARGHE in ALLUMINIO
Vedi Pag. 195-199



CORNICE METACRILATO CON SCATOLA



SPESSORE 13 MM

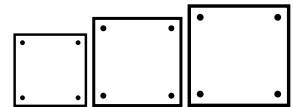
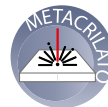

90714 QUADRATO

Art.	LxH/mm	DISCO/ mm
-1	100 x 100	50
-2	120 x 120	70
-3	140 x 140	90

DISCO NON INCLUSO

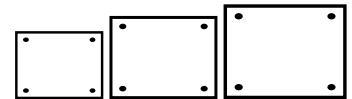

90715 RETTANGOLARE

Art.	LxH mm	TARGA mm
-1	130 x 95	90 X 55
-2	150 x 110	110 X 70
-3	180 x 140	130 X 90
-4	200 x 150	150 X 100

TARGA NON INCLUSA

PORTA TARGA CRISTALLO CON ASTUCCIO



90716 ROSSA

Art.	HXL/mm	Targa/mm
-1	135 x 180	150x100
-2	155 x 210	180x130
-3	175 x 240	200x150



90717 BLU

Art.	HXL/mm	Targa/mm
-1	135 x 180	150x100
-2	155 x 210	180x130
-3	175 x 240	200x150



PERSONALIZZAZIONE VERSIONE - 99

- NESSUN MINIMO D'ORDINE RICHIESTO
- COSTI PER MESSA IN MACCHINA, ELABORAZIONE GRAFICA A PROGETTO

CORNICE METACRILATO CON STAMPA E SCATOLA



SPESSORE 13 MM



SPESSORE 13 MM



90714-99 QUADRATO STAMPATO

Art.	LxH/mm
-1	100 x 100
-2	120 x 120
-3	140 x 140

DISCO INCLUSO



90715-99 RETTANGOLARE STAMPATO

Art.	LxH/mm
-1	130 x 95
-2	150 x 110
-3	180 x 140
-4	200 x 150

TARGA INCLUSA

SUPPORTI PER TARGHE

PORTA TARGA IN CRISTALLO, FONDO TRASPARENTE CON ASTUCCIO

Esempio di personalizzazione



SPESSORE 10 MM



90718

Art.	HXL/mm
-1	150 x 180
-2	170 x 210
-3	190 x 240

90718-99 CON LOGO STAMPATO

Art.	HXL/mm
-1	150 x 180
-2	170 x 210
-3	190 x 240



PERSONALIZZAZIONE VERSIONE - 99

- NESSUN MINIMO D'ORDINE RICHIESTO
- MESSA IN MACCHINA
- ELABORAZIONE GRAFICA A PROGETTO

PORTA TARGA IN CRISTALLO, FONDO BIANCO SUBLIMATICO CON ASTUCCIO



Esempio di personalizzazione

SPESSORE 10 MM



90719

Art.	HXL/mm
-1	135 x 180
-2	155 x 210
-3	175 x 240

PER STAMPA SUBLIMATICA
FONDO BIANCO

PORTA TARGA IN CRISTALLO, FONDO TRASPARENTE CON ASTUCCIO



90720

Art.	LxH/mm
-1	120 x 200
-2	140 x 220
-3	160 x 240

90720-99 CON LOGO STAMPATO

Art.	LxH/mm
-1	120 x 200
-2	140 x 220
-3	160 x 240



Esempio di personalizzazione

SPESSORE 6 MM e BASE IN LEGNO

BASE RIMOVIBILE



PERSONALIZZAZIONE VERSIONE - 99

- NESSUN MINIMO D'ORDINE RICHIESTO
- MESSA IN MACCHINA ELABORAZIONE GRAFICA A PROGETTO

PORTA TARGA IN CRISTALLO, FONDO BIANCO SUBLIMATICO CON ASTUCCIO

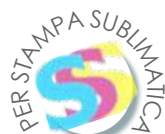

90721

Art.	LxH/mm
-1	120 x 200
-2	140 x 220
-3	160 x 240

PER STAMPA SUBLIMATICA FONDO BIANCO



SPESSORE 6 MM e BASE IN LEGNO

SUPPORTI TARGHE

PORTA TARGA IN METACRILATO TRASPARENTE CON ASTUCCIO



SPESSORE 4MM

Esempio di personalizzazione

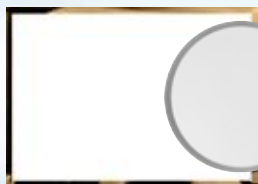

TARGHE in ALLUMINIO
Vedi Pag. 195-199

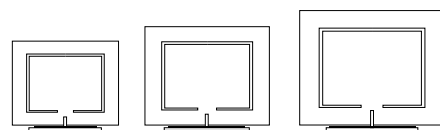

90722

Art.	LxH/mm	Targa/mm
-1	160 x 140	110 x 70
-2	175 x 155	130 x 90
-3	205 x 165	150 x 100

Targa non inclusa



SPESSORE 4 MM

Esempio di personalizzazione

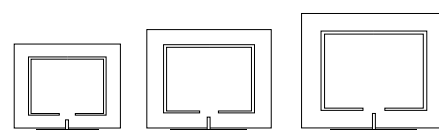

Personalizzazione

DAI COLORE E FORMA ALLE TUE IDEE
VERSIONE PERSONALIZZABILE
CON TAGLIO E STAMPA



90722-UV

Art.	LxH/mm
-1	160 x 140
-2	175 x 155
-3	205 x 165

PORTA TARGA IN METACRILATO TRASPARENTE CON ASTUCCIO

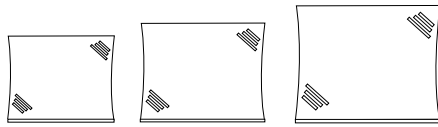

90723

Art.	LxH/mm	Targa/mm
-1	210 x 170	150X100
-2	255 x 215	180X130
-3	285 x 245	200X150

Targa non inclusa



SPESSORE 4 MM

Esempio di personalizzazione



TARGHE in ALLUMINIO
Vedi Pag. 195-199



SCATOLA DI PRESENTAZIONE
INCLUSA



VERSIONE -UV

PERSONALIZZATA

- **NESSUN MINIMO D'ORDINE RICHIESTO**
- COSTI PER REALIZZAZIONE IMPIANTO MESSA IN MACCHINA ED ELABORAZIONE GRAFICA A PROGETTO



SPESSORE 6 MM

Esempio di personalizzazione

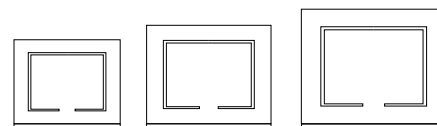

90724

Art.	LxH/mm	Targa/mm
-1	215 x 180	150X100
-2	255 x 210	180X130
-3	285 x 245	200X150

Targa non inclusa

Personalizzazione

DAI COLORE E FORMA ALLE TUE IDEE
VERSIONE PERSONALIZZABILE
CON TAGLIO E STAMPA

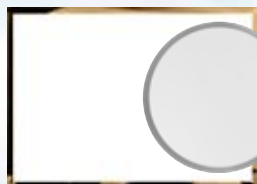

TARGHE in ALLUMINIO
Vedi Pag. 195-199

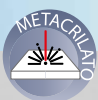

SPESSORE 6 MM

Esempio di personalizzazione

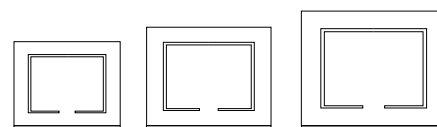

90724-UV

Art.	LxH/mm
-1	215 x 180
-2	255 x 210
-3	285 x 245

VERSIONE -UV

PERSONALIZZATA

- **NESSUN MINIMO D'ORDINE RICHIESTO**
- **COSTI PER REALIZZAZIONE IMPIANTO MESSA IN MACCHINA ED ELABORAZIONE GRAFICA A PROGETTO**

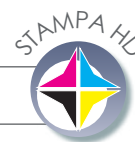



● 90726



● 90725



● 90727

SPESORE 6 MM

Art.	LxH/mm	Targa/mm
●● -1	215 x 180	150X100
●● -2	255 x 210	180X130
●● -3	285 x 245	200X150

Targa non inclusa

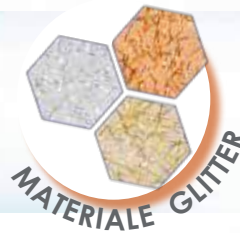

Personalizzazione
DAI COLORE E FORMA ALLE TUE IDEE
VERSIONE PERSONALIZZABILE
CON TAGLIO E STAMPA



- 90725-UV
- 90726-UV
- 90727-UV

Art.	LxH/mm
●● -1	215 x 180
●● -2	255 x 210
●● -3	285 x 245

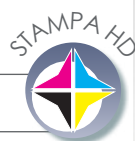

VERSIONE -UV

PERSONALIZZATA

- **NESSUN MINIMO D'ORDINE RICHIESTO**
- **COSTI PER REALIZZAZIONE IMPIANTO**
MESSA IN MACCHINA ED
ELABORAZIONE GRAFICA A PROGETTO



SPESORE 6 MM

Esempio
di personalizzazione



SPAZIO FRONTALE
PER INSERIRE
LA TARGA

DETTAGLIO
PROFILO

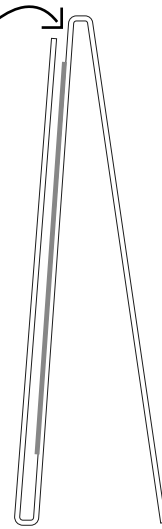

90728

Art.	LxH/mm	Targa/mm
-1	190 x 140	150 x 100
-2	220 x 170	180 x 130
-3	240 x 180	200 x 150

Targa non inclusa



TARGHE in ALLUMINIO
Vedi Pag. 195-199



SPAZIO FRONTALE
PER INSERIRE
LA TARGA

DETTAGLIO
PROFILO

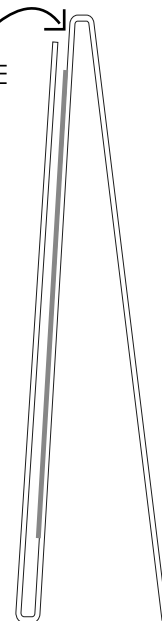

90729

Art.	LxH/mm	Targa/mm
-1	140 x 190	150 x 100
-2	170 x 220	180 x 130
-3	180 x 240	200 x 150

Targa non inclusa

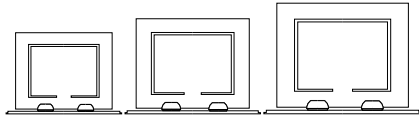

90730

Art.	LxH/mm	Targa/mm
-1	215 x 190	150 x 100
-2	255 x 210	180 x 130
-3	285 x 245	200 x 150

Targa non inclusa



SPESSORE 6 MM



TARGHE in ALLUMINIO
Vedi Pag. 195-199

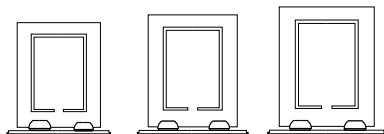

90731

Art.	LxH/mm	Targa/mm
-1	190 x 215	150 x 100
-2	220 x 255	180 x 130
-3	240 x 285	200 x 150

Targa non inclusa



SPESSORE 6 MM



Personalizzazione

DAI COLORE E FORMA ALLE TUE IDEE
VERSIONE PERSONALIZZABILE
CON TAGLIO E STAMPA

90730-UV

Art.	LxH/mm
-1	215 x 190
-2	255 x 210
-3	285 x 245

Esempio di personalizzazione

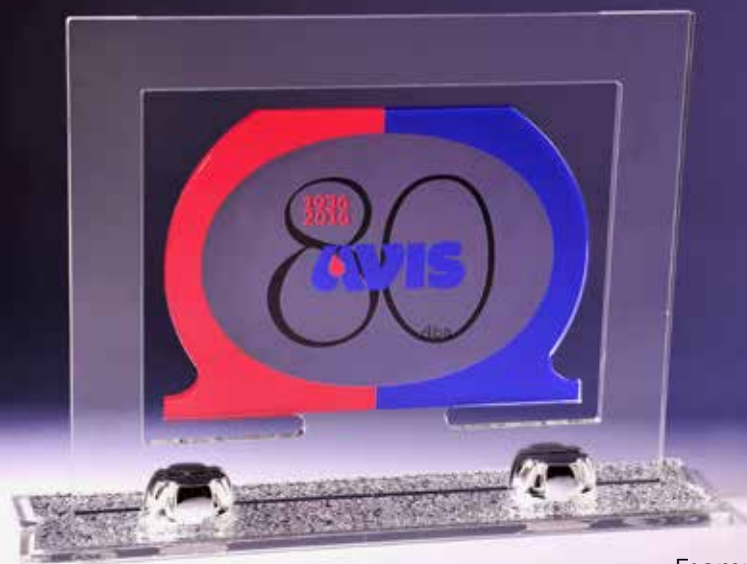

Esempio di personalizzazione



Esempio di personalizzazione

SPESSORE 4 MM

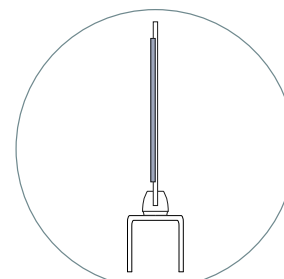

DETTAGLIO
PROFILO

VERSIONE -UV

PERSONALIZZATA

- **NESSUN MINIMO D'ORDINE RICHIESTO**
- COSTI PER REALIZZAZIONE IMPIANTO MESSA IN MACCHINA ED ELABORAZIONE GRAFICA A PROGETTO

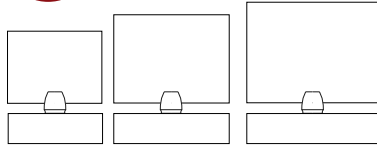
BEST
seller

90732

Art.	LxH/mm	Targa/mm
-1	210 x 215	150 x 100
-2	240 x 245	180 x 130
-3	260 x 265	200 X 150

Targa non inclusa



SPESSORE 6 MM

METACRILATO

TARGHE in ALLUMINIO
Vedi Pag. 195-199

Personalizzazione
DAI COLORE E FORMA ALLE TUE IDEE
VERSIONE PERSONALIZZABILE
CON TAGLIO E STAMPA

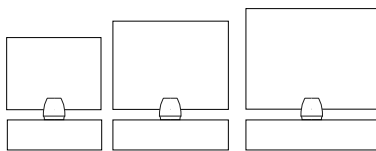

90732-UV

Art.	LxH/mm	Targa/mm
-1	210 x 215	150 x 100
-2	240 x 245	180 x 130
-3	260 x 265	200 X 150

VERSIONE -UV

PERSONALIZZATA

- **NESSUN MINIMO D'ORDINE RICHIESTO**
- COSTI PER REALIZZAZIONE IMPIANTO
MESSA IN MACCHINA ED
ELABORAZIONE GRAFICA A PROGETTO



SPESSORE 6 MM

METACRILATO

SUPPORTI TARGHE

PORTA TARGA IN METACRILATO TRASPARENTE CON ASTUCCIO



SPESSORE 6 MM

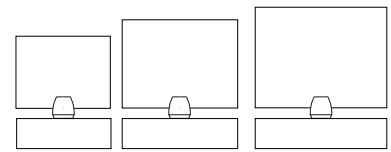

90733

Art.	LxH/mm	Targa/mm
-1	210 x 215	150 x 100
-2	240 x 245	180 x 130
-3	260 x 265	200 X 150

Targa non inclusa

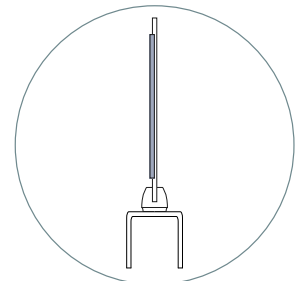

DETTAGLIO PROFILO



TARGHE in ALLUMINIO
Vedi Pag. 195-199



PORTA TARGA IN METACRILATO TRASPARENTE CON ASTUCCIO



SPESSORE 4 MM

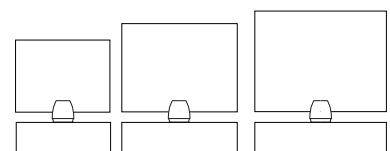

90734

Art.	LxH/mm	Targa/mm
-1	210 x 215	150 x 100
-2	240 x 245	180 x 130
-3	260 x 265	200 X 150

Targa non inclusa

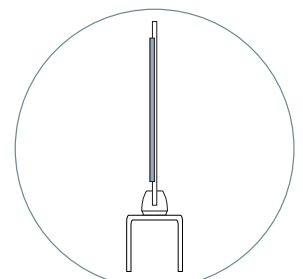

DETTAGLIO PROFILO

PORTA TARGA IN METACRILATO GLITTER CON ASTUCCIO

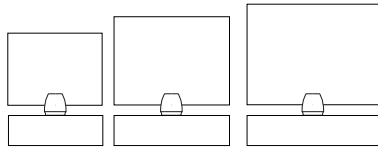

90735

Art.	LxH/mm	Targa/mm
-1	210 x 215	150 x 100
-2	240 x 245	180 x 130
-3	260 x 265	200 X 150

Targa non inclusa

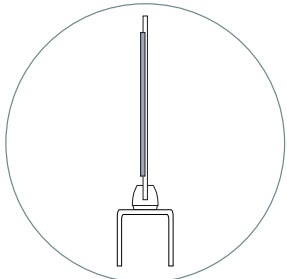

DETTAGLIO
PROFILO



SPESORE 6 MM



TARGHE in ALLUMINIO
Vedi Pag. 195-199



PORTA TARGA IN METACRILATO TRASPARENTE CON ASTUCCIO

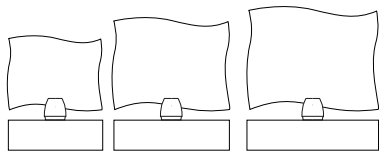

90736

Art.	LxH/mm	Targa/mm
-1	210 x 215	150 x 100
-2	240 x 245	180 x 130
-3	260 x 265	200 X 150

Targa non inclusa

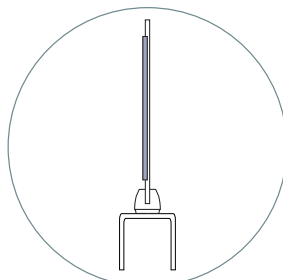

DETTAGLIO
PROFILO



SPESORE 6 MM

SUPPORTI TARGHE

PORTA TARGA IN METACRILATO TRASPARENTE CON ASTUCCIO



SPESORE 6 MM

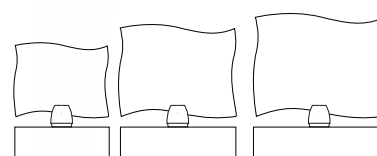

90737

Art.	LxH/mm	Targa/mm
-1	210 x 215	150 x 100
-2	240 x 245	180 x 130
-3	260 x 265	200 x 150

Targa non inclusa

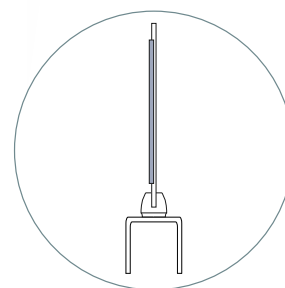

DETTAGLIO
PROFILO

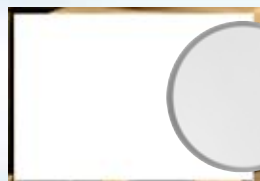

TARGHE in ALLUMINIO
Vedi Pag. 195-199



CREST RETTANGOLARE IN CERAMICA SUBLIMATICA CON SUPPORTO

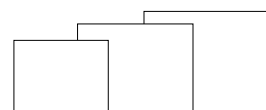

M3

Art.	L/mm	H/mm
170140	170	140
200170	200	170
240190	240	190

Fondo Bianco Lucido



SPESORE 4 MM



SUPPORTO
VELLUTO NERO

M1



Art.	L/mm	H/mm
180130	180	130
230180	230	180
250200	250	200
300230	300	230



SUPPORTO RIMOVIBILE



M2



Art.	L/mm	H/mm
180130	180	130
230180	230	180
250200	250	200
300230	300	230

Fondo Bianco Lucido



E8/2

Art.	LxL/mm	H/mm
220150	225 x 150	25
310220	305 x 220	25
350250	350 x 250	25

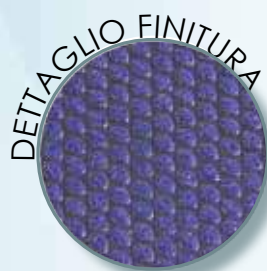

E6/1 TNT

Art.	LXH/mm	H/mm
210170	210 x 170	25
230190	230 x 190	25
260210	260 x 210	25
290230	290 x 230	25

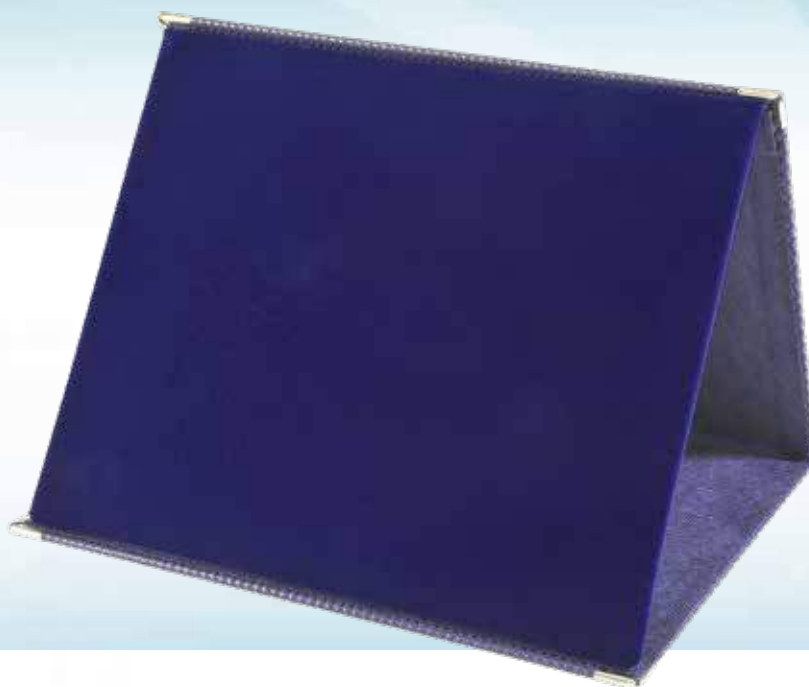
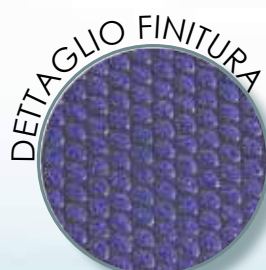

DETTAGLIO FINITURA



E6/2 VELLUTO LUX

Art.	LXH/mm	H/mm
210170	210 x 170	25
230190	230 x 190	25
260210	260 x 210	25
290230	290 x 230	25

E6/3 TNT

Art.	LXH/mm	H/mm
210170	210 x 170	10
290190	230 x 190	10
260210	260 x 210	10

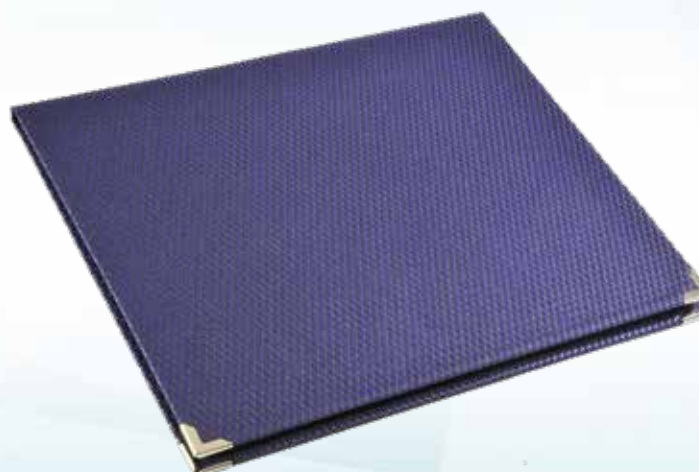



C1

Asta in legno

Art.	LxH/mm	Targa/mm
-2	250 x 200	180 x 130
-3	300 x 240	200 x 150

Targa non inclusa

SEZIONE CORNICE SCALA 1:1

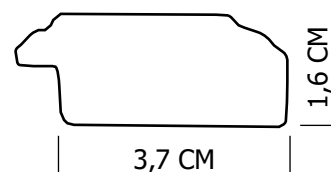

C2

Asta in legno

Art.	LxH/mm	Targa/mm
-2	250 x 200	180 x 130
-3	300 x 240	200 x 150

Targa non inclusa



SEZIONE CORNICE SCALA 1:1



- PASSEPARTOUT IN ABBINAMENTO (non incluso), VEDERE PAG. 194
 - TARGA IN ALLUMINIO E STAMPA NON INCLUSA.
- PER I MODELLI TARGA DISPONIBILI CONSULTATE DA Pag. 195-199





C6

Asta in legno

Art.	LxH/mm	Targa/mm
-2	250 x 200	180 x 130
-3	300 x 240	200 x 150

Targa non inclusa

SEZIONE CORNICE SCALA 1:1

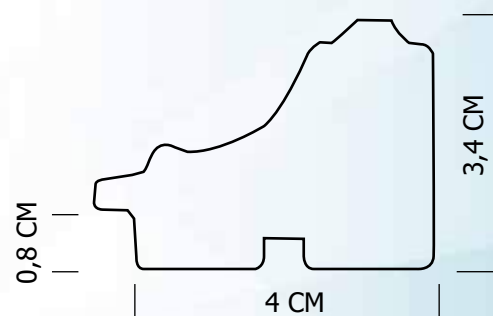

C10

Asta in legno

Art.	LxH/mm	Targa/mm
-2	250 x 200	180 x 130
-3	300 x 240	200 x 150

Targa non inclusa

SEZIONE CORNICE SCALA 1:1

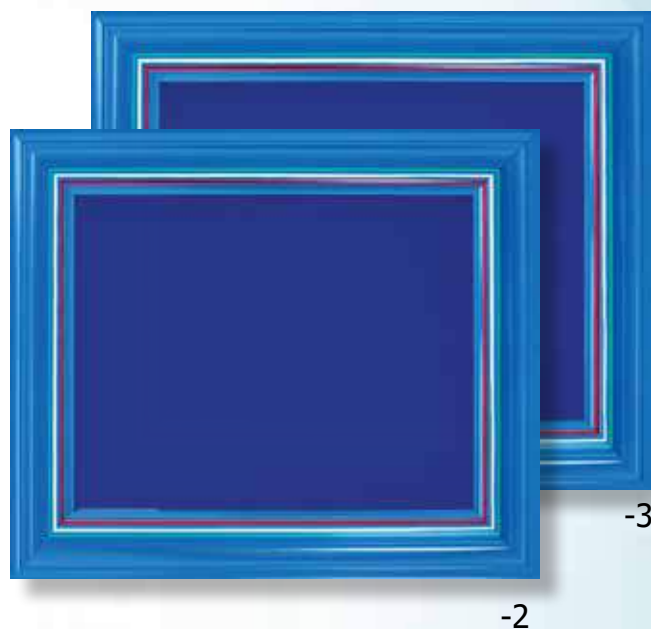
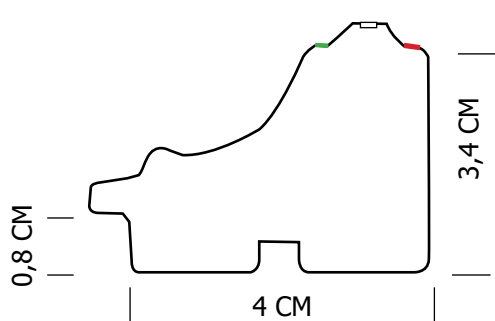

- PASSEPARTOUT IN ABBINAMENTO (non incluso), VEDERE PAG. 194
- TARGA IN ALLUMINIO E STAMPA NON INCLUSA.
PER I MODELLI TARGA DISPONIBILI CONSULTATE DA Pag. 195-199





PASS 01

PASSEPARTOUT PER CORNICI IN AVORIO/ARGENTO

Art.	SUPPORTO/mm
-1	CORNICE 180X230MM MISURA INTERNA 110x160MM
-2	CORNICE 200X250MM MISURA INTERNA 130x180MM
-3	CORNICE 240X300MM MISURA INTERNA 170x230MM

PASS 02

PASSEPARTOUT PER CORNICI IN AVORIO/ORO

Art.	SUPPORTO/mm
-1	CORNICE 180X230MM MISURA INTERNA 110x160MM
-2	CORNICE 200X250MM MISURA INTERNA 130x180MM
-3	CORNICE 240X300MM MISURA INTERNA 170x230MM



C9

Art.	LxH/mm	LxH/mm
	ESTERNO	INTERNO
-1	255 x 345	210 x 297

CORNICE IN LEGNO VENATO.
INTERNO MISURA A4 - SENZA DIPLOMA



C9-1_DIPLOMA

Art.	LxH/mm	LxH/mm
	ESTERNO	INTERNO
-1	255 x 345	210 x 297

CORNICE IN LEGNO VENATO.
INTERNO MISURA A4
CON DIPLOMA PERSONALIZZABILE IN DIVERSI MODELLI

BEST
seller

T1W-

BIANCA



Art.	H x L/mm
5017	50 X 17
5025	50 x 25
6025	60 x 25
7025	70 x 25
7035	70 x 35
8035	80 x 35
9040	90 x 40
9055	90 x 50
11050	110 x 50
11070	110 x 70
13090	130 x 90
150100	150 x 100
180130	180 x 130
200150	200 X 150

Prezzo
IMBATTIBILEBORDO TAGLIO AL VIVO
PER STAMPA SUBLIMATICA HDBEST
seller

T1G-

ORO

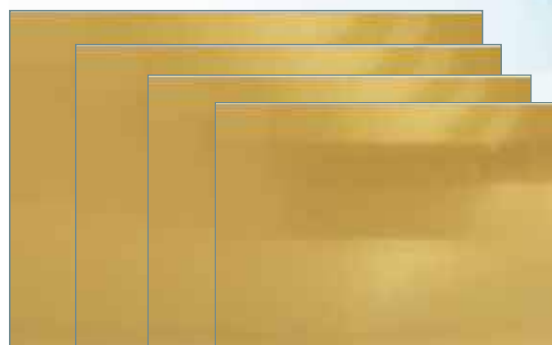

Art.	H x L/mm
13090	130 x 90
15010	150 x 100
180130	180 x 130
200150	200 x 150

BORDO TAGLIO AL VIVO
PER STAMPA SUBLIMATICA HDBEST
seller

T1S-

ARGENTO
SPAZZOLATO

Art.	H x L/mm
5017	50 X 17
5025	50 x 25
6025	60 x 25
7025	70 x 25
7035	70 x 35
8035	80 x 35
9040	90 x 40
9055	90 x 50
11050	110 x 50
11070	110 x 70
13090	130 x 90
150100	150 x 100
180130	180 x 130
200150	200 X 150

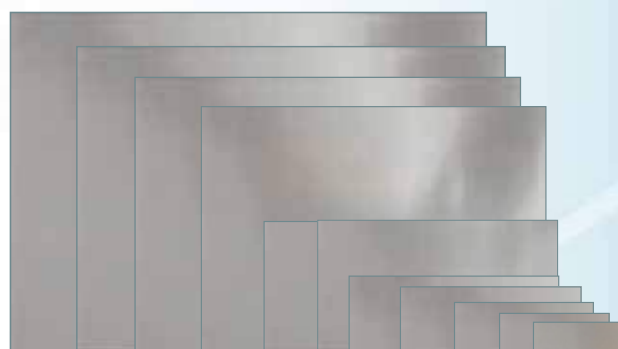
BORDO TAGLIO AL VIVO
PER STAMPA SUBLIMATICA HD

PER STAMPA SUBLIMATICA HD

BORDO ARGENTO LUCIDO
INTERNO ARGENTO



**BEST
seller**

T4SS-



Art.	HxL/mm
150100	150 x 100
180130	180 x 130
200150	200 x 150

PER STAMPA SUBLIMATICA HD

BORDO ARGENTO LUCIDO
INTERNO BIANCO



**BEST
seller**

T4SW-



Art.	HxL/mm
150100	150 x 100
180130	180 x 130
200150	200 x 150

PER STAMPA SUBLIMATICA HD

BORDO ORO LUCIDO
INTERNO BIANCO



**BEST
seller**

T4GW-



Art.	HxL/mm
150100	150 x 100
180130	180 x 130
200150	200 x 150



T8SS-



Art.	HxL/mm
180130	180 x 130
200150	200 x 150

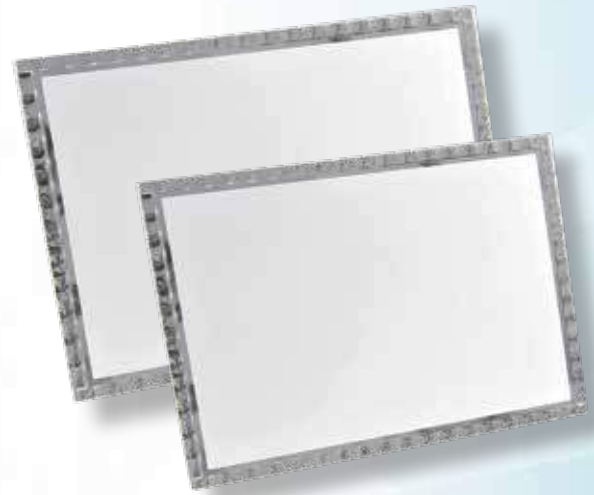

IN ALLUMINIO
BORDO SBALZATO
PER STAMPA SUBLIMATICA HD
BORDO SBALZATO ARGENTO LUCIDO
INTERNO ARGENTO



T8GG-



Art.	HxL/mm
180130	180 x 130
200150	200 x 150



IN ALLUMINIO
BORDO SBALZATO
PER STAMPA SUBLIMATICA HD
BORDO SBALZATO ORO LUCIDO
INTERNO ORO

FOGLIO CARTA
PER STAMPA SUBLIMATICA HD

TR-PASUB2

Art.	mm
TR-PASUB2	A4 297 x 210



PER STAMPA SUBLIMATICA HD

PERGAMENA CON BORDO
ARGENTO LUCIDO
INTERNO ARGENTO

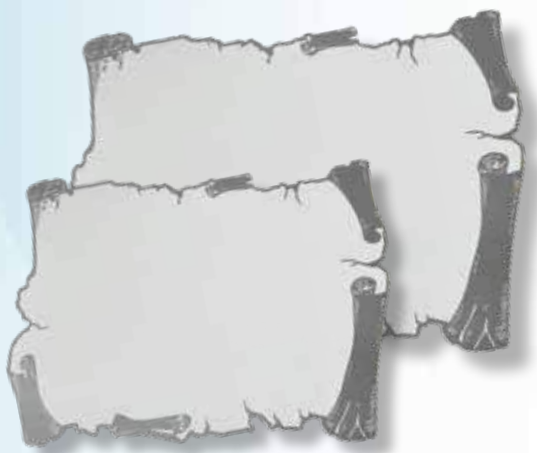

T7SS-



Art.	HXL/mm
160120	160 x 120
200150	200 x 150

PER STAMPA SUBLIMATICA HD

SCUDO CON BORDO
ARGENTO LUCIDO
INTERNO ARGENTO



T11SW-



Art.	HXL/mm
150120	154 x 122
180140	180 x 144



PER STAMPA SUBLIMATICA HD

TONDO CON BORDO
ARGENTO LUCIDO
INTERNO ARGENTO

D1-



Art.	COLORE	Ø/mm
G-25	ORO	25
G-32	ORO	32
G-50	ORO	50
S-25	ARGENTO	25
S-32	ARGENTO	32
S-50	ARGENTO	50
S-70	ARGENTO	70
W-25	BIANCO	25
W-32	BIANCO	32
W-50	BIANCO	50
W-70	BIANCO	70
W-90	BIANCO	90
W-110	BIANCO	110
W-140	BIANCO	140

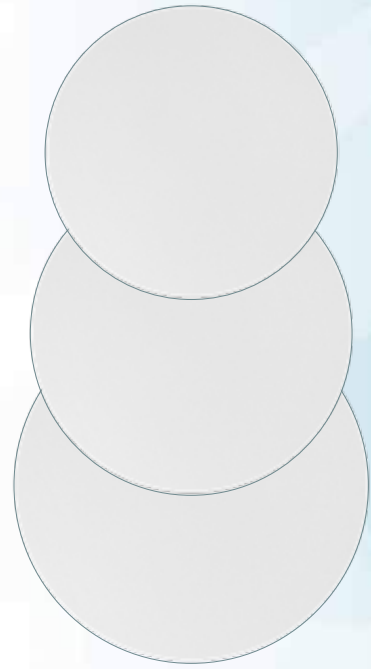
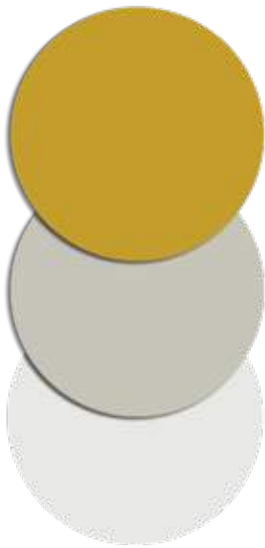

94025T

ROTOLO DA 1000 PZ.

Art.	Ø/mm
94025T	25

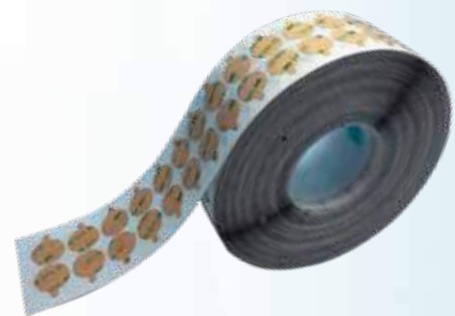



D13-J002

LASTRA ALLUMINIO
PER SUBLIMAZIONE



Art.	COLORE	HxLxS/mm
-1	ORO SPAZZOLATO	600 x 300 x 0,6
-2	ARGENTO SPAZZOLATO	600 x 300 x 0,6
-3	BRONZO LUCIDO	600 x 300 x 0,6
-4	BIANCO	600 x 300 x 0,6

HC

LASTRA ALLUMINIO
PER INCISIONE



Art.	COLORE	HxLxS/mm
-1	NERO ORO	600 x 300 x 0,6
-2	BLU ORO	600 x 300 x 0,6



TR

CONFEZIONE 100 PZ.

Art.		HxLxS/mm
PAPEL	TRASFER METALLICO	A4 297 x 210
PATEX	TRASFER TESSILE	A4 297 x 210
PASUB2	SUBLIMAZIONE	A4 297 x 210

F

Art.	COLORE	H X L / mm	Ø/mm
-11	BLU	130 x 310	25
-21	BLU	60 x 160	50
-12	VERDE	130 x 310	25
-22	VERDE	60 x 160	50
-14	GIALLO	130 x 310	25
-24	GIALLO	60 x 160	50
-16	ITA	130 X 310	50

Coccarda L. 310 mm,
con supporto in plastica



Coccarda L. 160 mm,
con spilla in metallo



Personalizzazione

VALORIZZA I TUOI PRODOTTI
UTILIZZANDO LE NOSTRE ETICHETTE Pag. 211-212

SPILLE

D28-9001

Art.	ESTERNO Ø/mm	INTERNO Ø/mm
-1	30	25
-2	18	14

D28-9002

Art.	ESTERNO Ø/mm	INTERNO Ø/mm
-1	30	25
-2	18	14





MD8001-32



Art.	Ø/mm	INSERTO ANT Ø/mm	INSERTO POST Ø/mm
● -G	32	25	25
● -S	32	25	25
● -B	32	25	25

Finitura lucidata a mano
Nastro NON incluso Pag. 210

Dal design semplificato
per incisione e stampa.
Retro



RETRO MEDAGLIA



MD8002-40



Finitura
lucidata a mano

Art.	Ø/mm	INSERTO ANT Ø/mm	INSERTO POST Ø/mm
● -G	40	25	33
● -S	40	25	33
● -B	40	25	33

Finitura lucidata a mano
Nastro NON incluso Pag. 210

Dal design semplificato
per incisione e stampa.
Retro



RETRO MEDAGLIA



MD8004-40



Art.	Ø/mm	INSERTO ANT Ø/mm	INSERTO POST Ø/mm
● -G	40	25	33
● -S	40	25	33
● -B	40	25	33

Finitura lucidata a mano
Nastro NON incluso Pag. 210

Dal design semplificato
per incisione e stampa.
Retro



RETRO MEDAGLIA



MD8006-40



Art.	Ø/mm	INSERTO ANT Ø/mm	INSERTO POST Ø/mm
● -G	40	25	33
● -S	40	25	33
● -B	40	25	33



RETRO MEDAGLIA

Finitura lucidata a mano
Nastro NON incluso Pag. 210

Dal design semplificato
per incisione e stampa.
Retro



MD1618-50

Art.	Ø/mm	INSERTO ANT Ø/mm	INSERTO POST mm
● -G	50	25	40 X 20
● -S	50	25	40 X 20
● -B	50	25	40 X 20



RETRO MEDAGLIA

Finitura lucidata a mano
Nastro NON incluso Pag. 210

Dal design semplificato
per incisione e stampa.
Retro



MD9607-50

Art.	Ø/mm	INSERTO ANT Ø/mm	INSERTO POST Ø/mm
● -G	50	25	33



RETRO MEDAGLIA

Finitura lucidata a mano
Nastro NON incluso Pag. 210

Dal design semplificato
per incisione e stampa.
Retro





MD8003-50



Art.	Ø/mm	INSERTO ANT Ø/mm	INSERTO POST Ø/mm
● -G	50	25	44
● -S	50	25	44
● -B	50	25	44

Finitura lucidata a mano
Nastro NON incluso Pag. 210

Dal design semplificato
per incisione e stampa.
Retro



RETRO MEDAGLIA



MD8005-50



Art.	Ø/mm	INSERTO ANT Ø/mm	INSERTO POST Ø/mm
● -G	50	25	44
● -S	50	25	44
● -B	50	25	44

Finitura lucidata a mano
Nastro NON incluso Pag. 210

Dal design semplificato
per incisione e stampa.
Retro



RETRO MEDAGLIA



MD8007-50



Art.	Ø/mm	INSERTO ANT Ø/mm	INSERTO POST Ø/mm
● -G	50	25	44
● -S	50	25	44
● -B	50	25	44

Finitura lucidata a mano
Nastro NON incluso Pag. 210

Dal design semplificato
per incisione e stampa.
Retro



RETRO MEDAGLIA

MD033-50

Art.	Ø/mm	INSERTO ANT Ø/mm	INSERTO POST Ø/mm
● -G	50	25/33	25/33
● -S	50	25/33	25/33
● -B	50	25/33	25/33

Finitura lucidata a mano
Nastro NON incluso Pag. 210



Retro

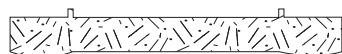

RETRO MEDAGLIA



MD001-70

Art.	Ø/mm	INSERTO ANT Ø/mm	INSERTO POST Ø/mm
● -G	50	25	44
● -S	50	25	44

Finitura lucidata a mano
Nastro NON incluso Pag. 210



Retro



RETRO MEDAGLIA



RP8114/T-B

Art.	Ø/mm
RP8114	40/50/70





MD184-70

Art.	Ø/mm	INSERTO ANT Ø/mm	INSERTO POST Ø/mm
● -G	70	50	50
● -S	70	50	50
● -B	70	50	50

Finitura lucidata a mano
Nastro NON incluso Pag. 210

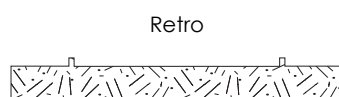

Retro



RETRO MEDAGLIA



MD1608-70

Art.	Ø/mm	INSERTO ANT Ø/mm	INSERTO POST Ø/mm
● -G	70	50	55 X 30
● -S	70	50	55 X 30
● -B	70	50	55 X 30

Finitura lucidata a mano
Nastro NON incluso Pag. 210



Retro



RETRO MEDAGLIA

VALORIZZA le tue medaglie!

NASTRI

SCEGLI IL NASTRO
PER LA MEDAGLIA
A PAG

Personalizzazione

Scegli tra tante immagini la tua personalizzazione



Etichette adesive resinate
su vinile adesivo permanente
ricoperte di resina Poliuretana





MDCR001

Art.	Ø/mm	SPESSORE Ø/mm
-70	70	5

MATERIALE CRISTALLO
Nastro NON incluso Pag. 210



MDCR001-99

Art.	Ø/mm	SPESSORE Ø/mm
-70	70	5

MATERIALE CRISTALLO
Nastro NON incluso Pag. 210

VERSIONE -99

PERSONALIZZATA

- **NESSUN MINIMO D'ORDINE RICHIESTO**
- COSTI PER MESSA IN MACCHINA ELABORAZIONE GRAFICA A PROGETTO



90600

H/mm	Targhetta
125	100x20



Personalizzazione

TRASFORMABILE IN MEDAGLIA
NASTRO NON INCLUSO
VEDI PAG.210



● 90600-2

● 90600-3

● 90600-1



AREA TARGHETTA
ADESIVA 100X20 mm



AREA BASE
DISCO Ø 50 mm





29008 50 mm

Art.	Ø/mm
-1G	70
-1S	70
-1B	70

DISCO NON INCLUSO
B-S-G RETRO MEDAGLIA NERO LUCIDO



29009 25 mm 33 mm

Art.	Ø/mm
-1G	60
-1S	60
-1B	60

DISCO NON INCLUSO
B-S-G RETRO MEDAGLIA NERO LUCIDO



29010 25 mm 33 mm

Art.	Ø/mm
-1G	60
-1S	60
-1B	60

DISCO NON INCLUSO
B-S-G RETRO MEDAGLIA NERO LUCIDO

29011 25 mm

Art.	Ø/mm
● -1G	70
● -1S	70
● -1B	70

DISCO NON INCLUSO
B-S-G RETRO MEDAGLIA NERO LUCIDO



DISCIPLINE

Possibilità di sviluppare
QUALSIASI disciplina.

29012 25 mm

Art.	Ø/mm
● -1G	60
● -1S	60
● -1B	60

DISCO NON INCLUSO
B-S-G RETRO MEDAGLIA NERO LUCIDO



29013 25 mm

Art.	Ø/mm
● -1G	60
● -1S	60
● -1B	60

DISCO NON INCLUSO
B-S-G RETRO MEDAGLIA NERO LUCIDO





Tricolore

Art.	H/mm
RI8010 - 1	10
RI8020 - 1	22

Art.	H/mm
------	------



RI8010 - 26	10
-------------	----



RI8010 - 24	10
-------------	----



RI8010 - 11	10
RI8020 - 12	22



RI8010 - 39	10
RI8020 - 11	22

Art.	H/mm
------	------



RI8020 - BRI- 14	22
------------------	----



RI8010 - 13	10
-------------	----



RI8010 - 07	10
RI8020 - 07	22



RI8010 - 27	10
-------------	----



Personalizzazione

VALORIZZA le tue medaglie!

Scegli tra tante immagini la tua personalizzazione

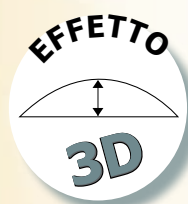

Etichette adesive resinare su vinile adesivo permanente ricoperte di resina Poliuretana





Trasparenti | **SENZA LOGO**
RESINATO NEUTRO

TONDO

TR-25
Ø 25 mm

MIN 80 pz	+320	+640
-----------	------	------

TR-32
Ø 32 mm

MIN 30 pz	+300	+600
-----------	------	------

TR-50
Ø 50 mm

MIN 20 pz	+300	+600
-----------	------	------



RETTANGOLARI

RESINATO NEUTRO

TR-50X25
50x25 mm

MIN 80 pz	+320	+640
-----------	------	------

TR-60X25
60x25 mm

MIN 40 pz	+320	+640
-----------	------	------

TR-70X25
70x25 mm

MIN 30 pz	+300	+600
-----------	------	------

Trasparenti | **CON LOGO**
RESINATO CON LOGO HD

TONDO

TR_UV-25
Ø 25 mm

MIN 35 pz	+75	+155	+275
-----------	-----	------	------

TR_UV-32
Ø 32 mm

MIN 25 pz	+55	+115	+205
-----------	-----	------	------

TR_UV-50
Ø 50 mm

MIN 35 pz	+75	+155	+275
-----------	-----	------	------



RETTANGOLARI

RESINATO CON LOGO HD

TR_UV-50X25
50x25 mm

MIN 35 pz	+75	+155
-----------	-----	------

TR_UV-60X25
60x25 mm

MIN 35 pz	+75	+155
-----------	-----	------

TR_UV-70X25
70x25 mm

MIN 25 pz	+55	+115
-----------	-----	------

CONDIZIONI DI VENDITA

Minimo d'ordine richiesto è la quantità minima indicata. **Nessun ulteriore addebito** con loghi vettoriali in Ai, Psd, Pdf, Eps, ed immagini con risoluzione 300 dpi. Su richiesta elaborazione grafica a progetto. **FORME SPECIALI A RICHIESTA**

Nessun addebito di messa in macchina per le misure standard (25, 32 e 50 mm).

CE-001

ETICHETTE ADESIVE IN VINILE
CON STAMPA COLORE HD

-25	-32	-50
MIN 80 pz	MIN 60 pz	MIN 40 pz

CE-001-25

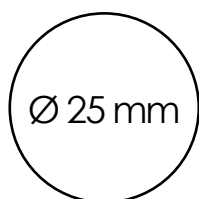

CE-001-32

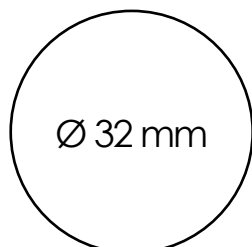

CE-001-50

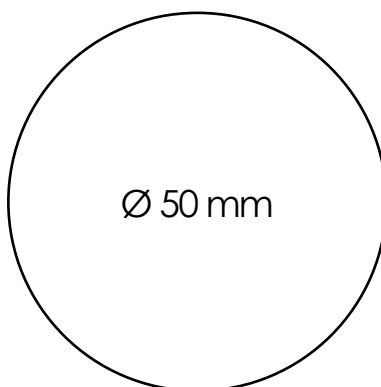

COD	DISCIPLINA
.01	BOWLING
.02	GIOCHI DA TAVOLA
.03	ARTI MARZIALI
.04	TIRO A SEGNO
.05	FRECCETTE
.06	BOCCE
.07	LACROSSE
.08	TIRO AL VOLO/PIATTELLO
.09	SQUASH
.10	CARTE
.11	SCI
.12	PUGILATO
.13	CLASSIFICHE
.14	EQUITAZIONE
.15	PALLACANESTRO
.16	CICLISMO
.17	MOTORI
.18	HOCKEY
.19	PALLAVOLO
.20	TENNIS
.21	BASEBALL
.22	ATLETICA
.23	GOLF
.24	NUOTO
.25	BADMINGTON
.26	CALCIO
.27	PING PONG
.28	DANZA
.29	PALLA A MANO
.30	PESCA

COD	DISCIPLINA
.31	MUSICA
.32	BILIARDO
.33	ARBITRO
.34	CINOFILI
.35	ARTE
.36	SUBAQUEO
.37	RUGBY
.38	EPOCA
.39	PALLANUOTO
.40	VELA
.41	POMPIERE
.42	PADEL
.43	ORNITOLOGIA
.44	OSCAR/VITTORIA
.45	PATTINAGGIO
.46	TAMBURELLO
.47	AFL
.48	PAINTBALL
.49	GINNASTICA
.50	TRIATHLON
.51	DODGEBALL
.52	CRICKET
.53	SCHERMA
.54	OZTAG
.55	CALCETTO
.56	CANOTTAGGIO
.57	WRESTLING
.58	SOLLEVAMENTO PESI
.59	CHEERLEADING
.60	NETBALL

COD	DISCIPLINA
.61	SOFTBALL
.62	SNOWBOARDING
.63	RACQUETBALL
.91	PORTA DISCO
.96	CURLING
.97	FOOTBALL AMERICANO
.98	TIRO CON L'ARCO
.99	REALIZZAZIONE SPECIALE

PERSONALIZZAZIONE

VERSIONE -99
A RICHIESTA POSSIBILITÀ DI SVILUPPARE
QUALSIASI DISCIPLINA



011



012



013



014



021



022



031



032



033



034



035



036



037



038



041



042



043



051



052



053



054



055



061



062



091

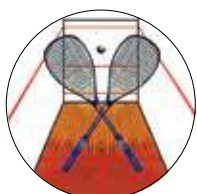

092



093



101



102



103



111



112



121



131



132



133



141



142



143



144



145



151



152



153



154



155



161



162



163



164



165



171



172



173



174



175



176



177



181



182



191



192



193



194



201



202



203



204



211



212



213

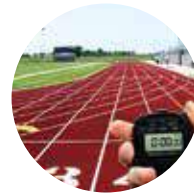

221



222



223



224



225



226



231

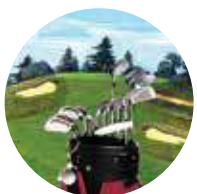

232



233



234



235



241



242



243



244



261



262



263



264



271



281



282



283

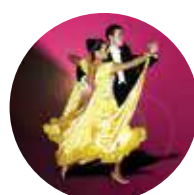

284



285



286



287



288



289



291



292



301



302



303



304



305



311



312



313



314



315



321



322



331



332



341



342



351



371



372



373



374



391



392



401



402



411



412



431



432



441



442



451



452



453



454



455



456



471



472



473



481



482



491



492



493



494



495



496



497



498



501



502



503



511



521



522



531



532



541



542



561



571



581



591



601



602



603



604



605



611



612



613



621



622



631



981



982



983



Personalizzazione

VALORIZZA le tue medaglie!

Scegli tra tante immagini la tua personalizzazione



Etichette adesive resinare su vinile adesivo permanente ricoperte di resina Poliuretana





MEDAGLIA
29002-1 99

Art.	Ø/mm
● -G	60
● -S	60
● -B	60
○ -w	60

B-S-G: RETRO MEDAGLIA NERO LUCIDO
NESSUN MINIMO D'ORDINE RICHIESTO



PERSONALIZZAZIONE

- NESSUN MINIMO D'ORDINE RICHIESTO
- COSTI PER MESSA IN MACCHINA, ELABORAZIONE GRAFICA A PROGETTO.



MEDAGLIA
29003-1 99

Art.	HxL/mm
● -G	70x50
● -S	70x50
● -B	70x50
○ -w	70x50

B-S-G: RETRO MEDAGLIA NERO LUCIDO
NESSUN MINIMO D'ORDINE RICHIESTO



MEDAGLIA
29004-1 99

Art.	HxL/mm
● -G	65X65
● -S	65X65
● -B	65X65
○ -w	65X65

B-S-G: RETRO MEDAGLIA NERO LUCIDO
NESSUN MINIMO D'ORDINE RICHIESTO





TONDO
29005-1

Art.	Ø/mm
● -G	60
● -S	60
● -B	60
○ -w	60



B-S-G RETRO MEDAGLIA NERO LUCIDO
NESSUN MINIMO D'ORDINE RICHIESTO

PERSONALIZZAZIONE

- NESSUN MINIMO D'ORDINE RICHIESTO
- COSTI PER MESSA IN MACCHINA, ELABORAZIONE GRAFICA A PROGETTO.



ESAGONO
29006-1

Art.	Ø/mm
● -G	60
● -S	60
● -B	60
○ -w	60

B-S-G RETRO MEDAGLIA NERO LUCIDO
NESSUN MINIMO D'ORDINE RICHIESTO



OVALE
29007-1

Art.	Ø/mm
● -G	60
● -S	60
● -B	60
○ -w	60

B-S-G RETRO MEDAGLIA NERO LUCIDO
NESSUN MINIMO D'ORDINE RICHIESTO



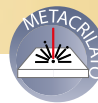

29807 CON ANELLO

Art.	Ø/mm	SPESSORE
-1	60	6
-2	70	6

METACRILATO TRASPARENTE
NASTRO NON INCLUSO



29807

Art.	Ø/mm	Spessore
-3	60	4
-4	70	4

METACRILATO TRASPARENTE
NASTRO NON INCLUSO

PERSONALIZZAZIONE

- NESSUN MINIMO D'ORDINE RICHIESTO
- COSTI PER MESSA IN MACCHINA, ELABORAZIONE GRAFICA A PROGETTO.

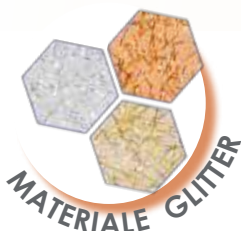

29819 CON ANELLO

Art.	Ø/mm	SPESSORE
● -G	70	6
● -S	70	6
● -B	70	6

NESSUN MINIMO D'ORDINE RICHIESTO
NASTRO NON INCLUSO





29815 CON ANELLO

Art.	HxL/mm	SPESSORE
-G	107 x 107	6
-S	107 x 107	6
-B	107 x 107	6

NESSUN MINIMO D'ORDINE RICHIESTO
NASTRO NON INCLUSO

PERSONALIZZAZIONE

PERSONALIZZATA

- **NESSUN MINIMO D'ORDINE RICHIESTO**
- **COSTI PER MESSA IN MACCHINA, ELABORAZIONE GRAFICA A PROGETTO**

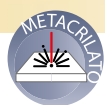

29817 CON ANELLO

Art.	HxL/mm	SPESSORE
-G	107 x 55	6
-S	107 x 55	6
-B	107 x 55	6

NESSUN MINIMO D'ORDINE RICHIESTO
NASTRO NON INCLUSO



29820 CON ANELLO

Art.	HxL/mm	SPESSORE
-G	90 x 55	6
-S	90 x 55	6
-B	90 x 55	6

NESSUN MINIMO D'ORDINE RICHIESTO
NASTRO NON INCLUSO



29823

Art.	HxL/mm	SPESSORE
● -G	58 x 98	4
● -S	58 x 98	4
● -B	58 x 98	4

NESSUN MINIMO D'ORDINE RICHIESTO
NASTRO NON INCLUSO

DISCIPLINE

Specificare nell'ordine il codice.
Possibilità di sviluppare
QUALSIASI disciplina



Cod. Basket
-151



-911

-201

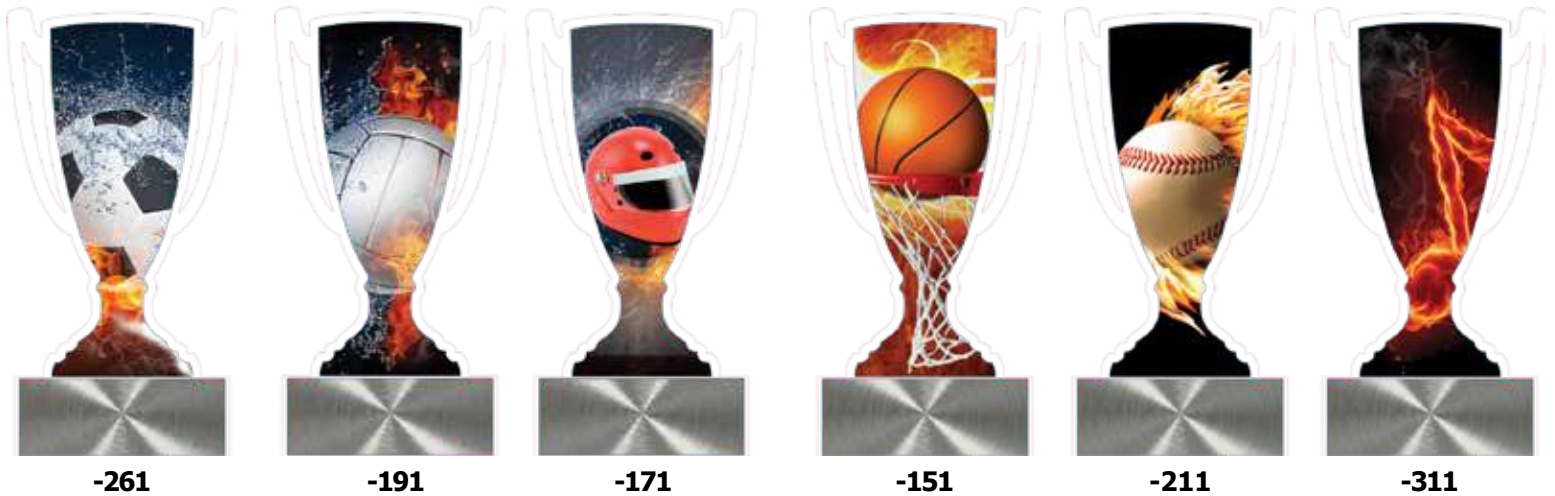

-261

-191

-171

-151

-211

-311

VERSIONE -99

PERSONALIZZATA

- **NESSUN MINIMO D'ORDINE RICHIESTO**
- COSTI PER MESSA IN MACCHINA,
ELABORAZIONE GRAFICA A PROGETTO



-99



-031

-321



29811

Art.	Ø/mm	SPESSORE
● -G	70	4
● -S	70	4
● -B	70	4

NESSUN MINIMO D'ORDINE RICHIESTO
NASTRO NON INCLUSO



VERSIONE -99

PERSONALIZZATA

- **NESSUN MINIMO D'ORDINE RICHIESTO**
- COSTI PER MESSA IN MACCHINA, ELABORAZIONE GRAFICA A PROGETTO

DISCIPLINE

Specificare nell'ordine il codice.
Possibilità di sviluppare
QUALSIASI disciplina



-111 - Sci



-241 - Nuoto



-091-Porta Disco

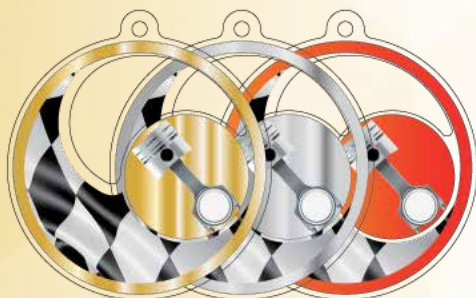

-171 - Motori



-261 - Calcio



-191 - Volley



-221 - Atletica



-281 - Danza



-031 - Arti Marziali



29824

50
mm

Art.	Ø/mm	SPESSORE
● -G	95	4
● -S	95	4
● -B	95	4

NESSUN MINIMO D'ORDINE RICHIESTO
NASTRO NON INCLUSO



-151

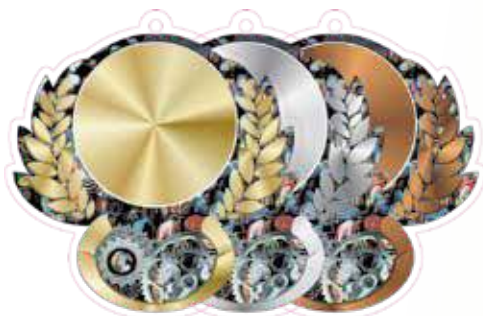

-161



-031



-171



-191



-201



-241



-261



-911



-221



29001 METACRILATO METALLICO

Art.	H/mm	L/mm
-1	60	60
-2	70	70
-3	70	50
-4	80	65

B-S-G RETRO MEDAGLIA NERO LUCIDO
NESSUN MINIMO D'ORDINE RICHIESTO
NASTRO NON INCLUSO



RI9901-1 SPESSORE 22 mm
LUNGHEZZA 920 mm

MIN 50 Pz. +150 Pz. +300 Pz.

NASTRO PERSONALIZZATO:

Stampa in quadricromia bilaterale.
Tessuto raso altà qualità.
Possibilità di abbinare il nastro con la medaglia Art. 29001-2-3-4-5-6-7.

Ordinare separatamente.
15gg. lavorativi per la produzione



7005 METACRILATO TRASPARENTE

Art.	HxL/mm	SPESSORE
-1	50 x 50	4
-2	70 x 70	4
-3	90 x 90	4

NASTRO NON INCLUSO





6003

Art.	Ø/mm	SPESSORE	INSERTO
-1	90	3+3	65
-2	105	3+3	80
-3	120	3+3	90

NESSUN MINIMO D'ORDINE RICHIESTO
NASTRO NON INCLUSO

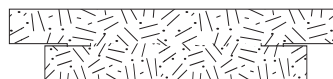

Fronte

PERSONALIZZAZIONE

- NESSUN MINIMO D'ORDINE RICHIESTO
- COSTI PER MESSA IN MACCHINA, ELABORAZIONE GRAFICA A PROGETTO.



PERSONALIZZAZIONE

- NESSUN MINIMO D'ORDINE RICHIESTO
- COSTI PER REALIZZAZIONE IMPIANTO, MESSA IN MACCHINA, ELABORAZIONE GRAFICA A PROGETTO.



7005 CON ANELLO

Art.	HxL/mm	SPESSORE
-4	50 x 50	6
-5	70 x 70	6
-6	90 x 90	6

NASTRO NON INCLUSO





DETTAGLIO



MEDAGLIE IN METALLO
REALIZZATE SU MISURA CON
NASTRO PERSONALIZZATO

CONTATTATECI PER AVERE
UN PREVENTIVO

DETTAGLIO



DETTAGLIO





DIAMO FORMA E COLORE ALLE TUE IDEE

SPILLE E FERMACARTE



**REALIZZATI SU MISURA
CONTATTATECI PER AVERE UN PREVENTIVO**

MAGNETI PERSONALIZZATI

PERSONALIZZATI CON STAMPA QUADRICROMIA A UN LATO



MAG METACRILATO BIANCO

Art.	H/mm	L/mm
-60	60	60
-7050	70	50

RETRO CON MAGNETE

- **NESSUN MINIMO D'ORDINE RICHIESTO**
- COSTI PER MESSA IN MACCHINA ELABORAZIONE GRAFICA A PROGETTO



RETRO CON MAGNETE



PERSONALIZZATI NELLA FORMA e NEL COLORE CON IL TUO LOGO



MAGUV METACRILATO BIANCO

Art.	H/mm	L/mm
-6060	60	60
-7050	70	50
-7070	70	70

RETRO CON MAGNETE

- **NESSUN MINIMO D'ORDINE RICHIESTO**
- COSTI PER REALIZZAZIONE IMPIANTO, MESSA IN MACCHINA, ELABORAZIONE GRAFICA A PROGETTO

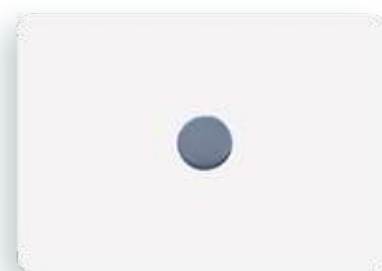

RETRO CON MAGNETE



ACRY
Color



Un prodotto **NUOVO**,
VINCENTE ed **ESCLUSIVO**.
Da oggi puoi
dare forma e colore
alle tue idee.



Esempio di personalizzazione nella FORMA e nella STAMPA



ART. 90001

**PERSONALIZZAZIONE
ABBINA IL TROFEO
CON LA MEDAGLIA**

Personalizza la tua premiazione nella forma e nel colore

Con questa collezione di Trofei potrai avere la medaglia abbinata.

**MATERIALE METACRILATO SPESSORE 3 mm
QUATTRO COLORI
FINITURA METALLO: Oro. Argento. Bronzo
Bianco Neutro**

- NESSUN MINIMO D'ORDINE RICHIESTO
- COSTI PER REALIZZAZIONE IMPIANTO, MESSA IN MACCHINA, ELABORAZIONE GRAFICA A PROGETTO.

90001 TROFEO

	Art.	H/mm	L/mm
	-1	140	70
	-2	160	80
	-3	180	90
	-4	120	100
	-5	130	110
	-6	150	120

B-S-G: RETRO MEDAGLIA NERO LUCIDO
NESSUN MINIMO D'ORDINE RICHIESTO





Esempio di personalizzazione nella STAMPA

Un prodotto NUOVO, VINCENTE ed ESCLUSIVO.
 Il tuo evento non passerà inosservato



29001 MEDAGLIA

Art.	H/mm	L/mm
-1	60	60
-2	70	70
-3	70	50
-4	80	65

B-S-G: RETRO MEDAGLIA NERO LUCIDO
 NESSUN MINIMO D'ORDINE RICHIESTO



Un prodotto NUOVO,
VINCENTE ed ESCLUSIVO.
Da oggi puoi
dare forma e colore
alle tue idee.



ART. 6002

PERSONALIZZAZIONE

STAMPA: Quadricomia

MATERIALE: Metacrilato BIANCO

SPESSORE : 3 mm

BASE: Marmo

- NESSUN MINIMO D'ORDINE RICHIESTO
- COSTI PER REALIZZAZIONE IMPIANTO, MESSA IN MACCHINA, ELABORAZIONE GRAFICA A PROGETTO.

6002

Art.	H/mm	L/mm
-1	150	80
-2	170	70
-3	190	100

6002

Art.	H/mm	L/mm
-4	120	120
-5	140	140
-6	160	150



Esempi di personalizzazione



ART. 6002 ESEMPI

PERSONALIZZAZIONE

STAMPA: Quadricomia

MATERIALE: Metacrilato BIANCO

SPESSORE: 3 mm

BASE: Marmo

- NESSUN MINIMO D'ORDINE RICHIESTO
- COSTI PER REALIZZAZIONE IMPIANTO, MESSA IN MACCHINA, ELABORAZIONE GRAFICA A PROGETTO.







ART. 7006

PERSONALIZZAZIONE

STAMPA: Quadricomia + bianco coprente

MATERIALE: Metacrilato TRASPARENTE

SPESSORE: 4 mm

BASE: Marmo

- NESSUN MINIMO D'ORDINE RICHIESTO
- COSTI PER REALIZZAZIONE IMPIANTO, MESSA IN MACCHINA, ELABORAZIONE GRAFICA A PROGETTO.

7006

Art.	H/mm	L/mm
-1	160	90
-2	185	100
-3	210	110

7006

Art.	H/mm	L/mm
-4	120	120
-5	130	140
-6	140	150



Esempi di personalizzazione

Un prodotto **NUOVO**,
VINCENTE ed **ESCLUSIVO**.
Da oggi puoi
dare forma e colore
alle tue idee.



ART. 6010

PERSONALIZZAZIONE

STAMPA: Quadricomia + bianco coprente

MATERIALE: Metacrilato TRASPARENTE

SPESSORE: 6 mm

BASE: Marmo

- NESSUN MINIMO D'ORDINE RICHIESTO
- COSTI PER REALIZZAZIONE IMPIANTO, MESSA IN MACCHINA, ELABORAZIONE GRAFICA A PROGETTO.

6010

Art.	H/mm	L/mm
-1	170	120
-2	200	130
-3	220	140

6010

Art.	H/mm	L/mm
-4	170	120
-5	200	130
-6	220	140



Un prodotto **NUOVO**,
VINCENTE ed **ESCLUSIVO**.
Da oggi puoi
dare forma e colore
alle tue idee.



Esempi di personalizzazione

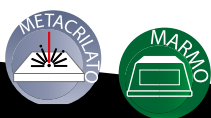

ART. 6010 ESEMPI

PERSONALIZZAZIONE

STAMPA: Quadricomia + bianco coprente

MATERIALE: Metacrilato TRASPARENTE

SPESSORE: 6 mm

BASE: Marmo

- NESSUN MINIMO D'ORDINE RICHIESTO
- COSTI PER REALIZZAZIONE IMPIANTO, MESSA IN MACCHINA, ELABORAZIONE GRAFICA A PROGETTO.



Un prodotto NUOVO,
VINCENTE ed ESCLUSIVO.
Da oggi puoi
dare forma e colore
alle tue idee.



Esempi di
personalizzazione

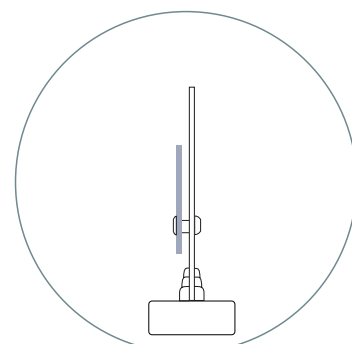

DETTAGLIO
PROFILO



ART. 6000 CON APPLICAZIONE

PERSONALIZZAZIONE

STAMPA: Quadricomia + bianco coprente

MATERIALE: Metacrilato TRASPARENTE

SPESSORE: 6 mm

BASE: Marmo

- NESSUN MINIMO D'ORDINE RICHIESTO
- COSTI PER REALIZZAZIONE IMPIANTO, MESSA IN MACCHINA, ELABORAZIONE GRAFICA A PROGETTO.

6000

Art.	H/mm	L/mm
-1	240	
-2	270	
-3	300	



ART. 7007

PERSONALIZZAZIONE

STAMPA: Quadricomia + bianco coprente

MATERIALE: Metacrilato TRASPARENTE

SPESSORE: 4 mm

BASE: Metacrilato

- NESSUN MINIMO D'ORDINE RICHIESTO
- COSTI PER REALIZZAZIONE IMPIANTO, MESSA IN MACCHINA, ELABORAZIONE GRAFICA A PROGETTO.

7007

Art.	H/mm	L/mm
-1	155	125
-2	165	140
-3	145	155

7007

Art.	H/mm	L/mm
-4	155	175
-5	165	190
-6	175	215



Un prodotto NUOVO,
VINCENTE ed ESCLUSIVO.
Da oggi puoi
dare forma e colore
alle tue idee.

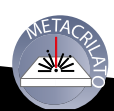

ART. 7007 ESEMPI

PERSONALIZZAZIONE

STAMPA: Quadricomia + bianco coprente
MATERIALE: Metacrilato TRASPARENTE
SPESSORE: 4 mm
BASE: Metacrilato

- NESSUN MINIMO D'ORDINE RICHIESTO
- COSTI PER REALIZZAZIONE IMPIANTO, MESSA IN MACCHINA, ELABORAZIONE GRAFICA A PROGETTO.



Un prodotto NUOVO,
VINCENTE ed ESCLUSIVO.
Da oggi puoi
dare forma e colore
alle tue idee.



Esempi di
personalizzazione



ART. 6007

PERSONALIZZAZIONE

STAMPA: Quadricomia + bianco coprente

MATERIALE: Metacrilato TRASPARENTE

SPESSORE: 6 mm

BASE: ABS

- NESSUN MINIMO D'ORDINE RICHIESTO
- COSTI PER REALIZZAZIONE IMPIANTO, MESSA IN MACCHINA, ELABORAZIONE GRAFICA A PROGETTO.

6007

Art.	H/mm	L/mm
-1	270	120
-2	320	140
-3	360	160

6007

Art.	H/mm	L/mm
-4	270	170
-5	320	190
-6	360	200

Un prodotto NUOVO,
VINCENTE ed ESCLUSIVO.
Da oggi puoi
dare forma e colore
alle tue idee.



ACRY
Color

Esempi di
personalizzazione



Un prodotto NUOVO,
VINCENTE ed ESCLUSIVO.
Da oggi puoi
dare forma e colore
alle tue idee.



ART. 6007 ESEMPI

PERSONALIZZAZIONE

STAMPA: Quadricomia + bianco coprente

MATERIALE: Metacrilato TRASPARENTE

SPESSORE: 6 mm

BASE: ABS

- NESSUN MINIMO D'ORDINE RICHIESTO
- COSTI PER REALIZZAZIONE IMPIANTO, MESSA IN MACCHINA, ELABORAZIONE GRAFICA A PROGETTO.

6004

Art.	H/mm
-1	300
-2	330
-3	360



6005

Art.	H/mm
-1	300
-2	340
-3	380



PERSONALIZZAZIONE

STAMPA: Quadricomia + bianco coprente
MATERIALE: Metacrilato TRASPARENTE
SPESSORE: 6 mm
BASE: ABS

- NESSUN MINIMO D'ORDINE RICHIESTO
- COSTI PER REALIZZAZIONE IMPIANTO, MESSA IN MACCHINA, ELABORAZIONE GRAFICA A PROGETTO.

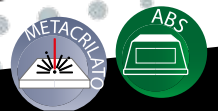

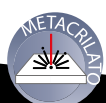

ART. 6008

PERSONALIZZAZIONE

STAMPA: Quadricomia + bianco coprente

MATERIALE: Metacrilato TRASPARENTE

SPESSORE: 6 mm

BASE: Metacrilato

- NESSUN MINIMO D'ORDINE RICHIESTO
- COSTI PER REALIZZAZIONE IMPIANTO, MESSA IN MACCHINA, ELABORAZIONE GRAFICA A PROGETTO.

6008

Art.	H/mm	L/mm
-1	270	220
-2	310	260
-3	350	300

6008

Art.	H/mm	L/mm
-4	190	260
-5	210	300
-6	230	350

Un prodotto NUOVO,
VINCENTE ed ESCLUSIVO.
Da oggi puoi
dare forma e colore
alle tue idee.





Un prodotto NUOVO,
VINCENTE ed ESCLUSIVO.

Da oggi puoi
dare forma e colore
alle tue idee.

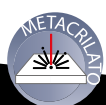

ART. 6008 ESEMPI

PERSONALIZZAZIONE

STAMPA: Quadricomia + bianco coprente

MATERIALE: Metacrilato TRASPARENTE

SPESSORE: 6 mm

BASE: Metacrilato

- NESSUN MINIMO D'ORDINE RICHIESTO
- COSTI PER REALIZZAZIONE IMPIANTO, MESSA IN MACCHINA, ELABORAZIONE GRAFICA A PROGETTO.







ART. 6009

PERSONALIZZAZIONE

STAMPA: Quadricomia + bianco coprente

MATERIALE: Metacrilato TRASPARENTE

SPESSORE: 6 mm

BASE: Legno

- NESSUN MINIMO D'ORDINE RICHIESTO
- COSTI PER REALIZZAZIONE IMPIANTO, MESSA IN MACCHINA, ELABORAZIONE GRAFICA A PROGETTO.

6009

Art.	H/mm	L/mm
-1	190	260
-2	210	300
-3	230	350

6009

Art.	H/mm	L/mm
-4	270	220
-5	310	260
-6	350	300



Un prodotto NUOVO,
VINCENTE ed ESCLUSIVO.
Da oggi puoi
dare forma e colore
alle tue idee.





PERSONALIZZAZIONE

STAMPA: Quadricomia + bianco coprente

MATERIALE: Metacrilato di vari spessori

4 tasselli di fissaggio inclusi.

Possibilità di avere svariate misure rispetto a quelle indicate

- NESSUN MINIMO D'ORDINE RICHIESTO
- COSTI PER MESSA IN MACCHINA, ELABORAZIONE GRAFICA A PROGETTO.

6012

Art.	SPESSORE	L/mm	H/mm
-1- 401	4 mm	290	210
-2 - 401	4 mm	420	290

Art.	SPESSORE	L/mm	H/mm
-1- 601	6 mm	290	210
-2 - 601	6 mm	420	290

Art.	SPESSORE	L/mm	H/mm
-1- 1001	10 mm	290	210
-2 - 1001	10 mm	420	290

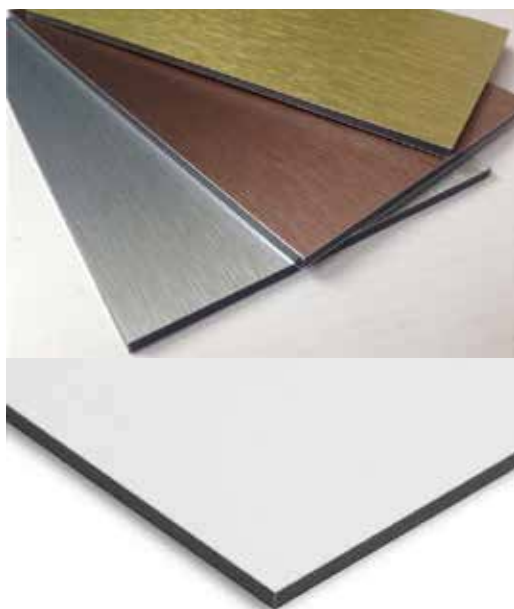

ORO
ARGENTO
BRONZO
BIANCO

80033

Art.	L/mm	H/mm
-1	290	210
-2	420	290

PERSONALIZZAZIONE

STAMPA: Quadricomia + bianco coprente

MATERIALE: Alluminio dibond 3 mm

4 tasselli di fissaggio a muro inclusi.

Possibilità di avere svariate misure rispetto a quelle indicate.

- NESSUN MINIMO D'ORDINE RICHIESTO
- COSTI PER MESSA IN MACCHINA, ELABORAZIONE GRAFICA A PROGETTO.

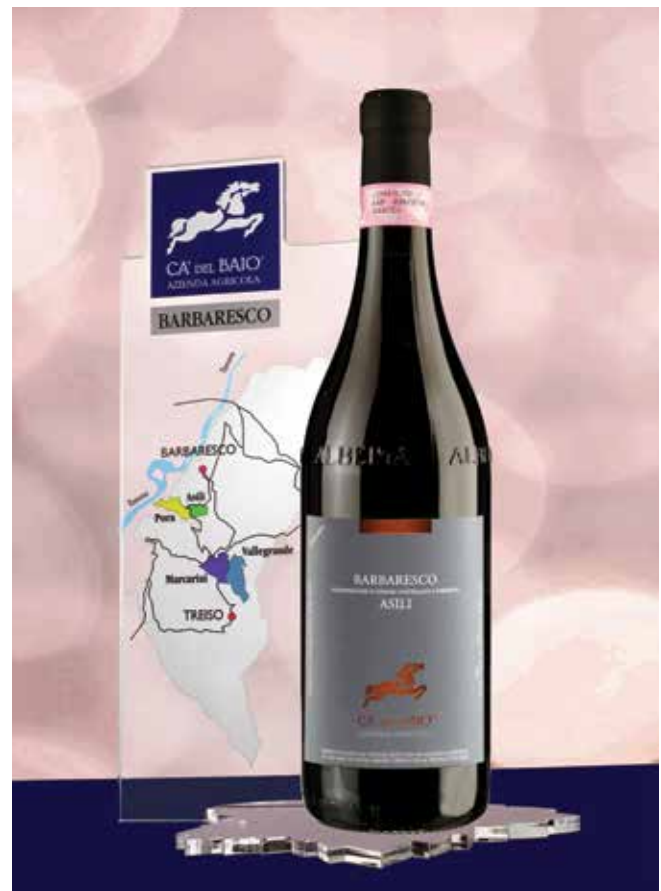

PERSONALIZZAZIONE

STAMPA: Quadricomia + bianco coprente

MATERIALE: Metacrilato di vari spessori

- NESSUN MINIMO D'ORDINE RICHIESTO
- COSTI PER REALIZZAZIONE IMPIANTO, MESSA IN MACCHINA, ELABORAZIONE GRAFICA A PROGETTO.

6011

Art.	H/mm	L/mm
-4	300	100
-5	300	160

CODICE	PAG
6000	242
6002	232
6003	225
6004	249
6005	249
6007	246
6008	250
6009	254
6010	238
6011	258
6012	256
7005	224
7006	236
7007	244
28811	222
28823	221
29001	3 - 224 231
29002	5 - 217
29003	5 - 217
29004	5 - 217
29005	7 - 218
29006	7 - 218
29007	7 - 218
29008	9 - 208
29009	9 - 208
29010	9 - 208
29011	10 - 209
29012	10 - 209
29013	10 - 209
29807	219
29815	220
29817	220
29819	219
29820	220
29824	223
80033	257
90001	3 - 230
90002	4
90003	4
90004	4
90005	6
90006	6
90007	6
90008	8
90009	8
90010	8
90100	72
90101	72
90103	73
90104	73
90105	74
90106	74
90108	75
90109	75
90110	76
90111	77
90114	77

CODICE	PAG
90115	79
90116	79
90117	79
90118	80
90119	80
90120	81
90121	81
90122	82
90123	82
90125	83
90203	84
90204	84
90205	85
90206	85
90210	86
90211	86
90212	87
90213	87
90214	89
90215	89
90216	89
90217	90
90218	90
90219	91
90220	92
90221	92
90222	93
90223	93
90224	94
90300	97
90301	97
90302	97
90303	98
90304	98
90305	99
90306	99
90307	100
90308	100
90309	101
90310	101
90311	102
90312	102
90313	103
90314	103
90315	105
90316	105
90317	105
90318	106
90319	106
90320	107
90321	107
90322	109
90323	109
90324	109
90325	110
90326	111
90327	111

CODICE	PAG
90328	112
90329	112
90330	113
90331	113
90332	114
90333	114
90334	115
90335	115
90336	116
90337	116
90338	117
90339	117
90340	118
90400	120
90401	119
90402	119
90403	120
90404	121
90405	121
90406	122
90407	122
90408	123
90409	124
90410	123
90411	125
90412	126
90413	127
90414	128
90415	128
90416	129
90417	130
90418	131
90419	132
90420	133
90422	134
90423	134
90424	135
90425	135
90426	136
90427	136
90428	137
90429	137
90430	138
90431	139
90432	140
90433	141
90500	142
90501	142
90502	143
90503	143
90504	145
90505	144
90506	146
90507	147
90508	145
90509	148
90510	149

CODICE	PAG
90511	150
90512	151
90513	152
90515	153
90516	154
90517	155
90518	155
90519	156
90520	157
90521	158
90523	159
90524	160
90525	160
90527	161
90529	163
90530	164
90531	166
90532	167
90533	166
90534	167
90600	10 - 207
90604	11
90605	12
90606	12
90607	13
90608	13
90609	14
90610	14
90611	14
90612	14
90613	15
90614	15
90615	16
90616	17
90621	18
90622	19
90623	18
90624	19
90625	18
90626	20
90627	20
90628	21
90629	21
90630	22
90631	23
90632	23
90633	24
90634	24
90635	24
90636	25
90637	25
90638	26
90639	26
90641	26
90642	27
90643	27
90644	28

CODICE	PAG
90645	29
90646	30
90647	31
90648	32
90649	33
90651	34 - 172
90652	35 - 170
90653	36 - 170
90655	37
90657	40
90658	40
90659	41
90660	42
90661	42
90662	43
90663	43
90664	44
90665	45
90666	45
90667	46
90668	46
90669	46
90670	47
90671	47
90673	48
90674	49
90675	50
90676	51
90677	52
90678	53
90679	54
90680	55
90681	56
90682	58
90683	60
90684	62
90686	66
90687	68
90688	70
90689	71
90690	71
90700	168
90701	168
90702	169
90703	169
90704	171
90707	171
90709	172
90710	173
90711	173
90713	174
90714	174
90715	174
90716	175
90717	175
90718	176
90719	176

CODICE	PAG
90720	177
90721	177
90722	178
90723	179
90724	180
90725	181
90726	181
90727	181
90728	182
90729	182
90730	183
90731	183
90732	185
90733	186
90734	186
90735	187
90736	187
90737	188
90110UV	76
90224UV	95
90325UV	110
90409CC	124
90412-99	126
90413CC	127
90416CC	129
90417CC	130
90418CC	131
90419CC	132
90421CC	133
90425CC	135
90430CC	138
90431CC	139
90432CC	140
90510-99	149
90511-99	150
90512-99	151
90520UV	157
90528 PA	39 - 162
90649UV	33
90651-99	34 - 172
90652-99	35 - 170
90653-99	36 - 170
90675-99	50
90676-99	51
90677-99	52
90678-99	53
90679-99	54
90680-99	55
90681-911	57
90682-911	59
90683-911	61
90684-911	63
90685B	64
90685G	64
90685S	64
90687-91	69
90688-99	70

CODICE	PAG
90689-99	70
90690-99	71
90704-99	171
90707-99	171
90709-99	172
90710-99	173
90711-99	173
90714-99	175
90715-99	175
90718-99	176
90720-99	177
90722UV	178
90724UV	180
90725UV	181
90726UV	181
90727UV	181
90730UV	184
90732UV	185
94025T	199
C1	192
C10	193
C2	192
C6	193
C9	194
C9-1_DIPLOMA	194
CE-001-25	212
CE-001-32	212
CE-001-50	212
D1	199
D13-J002	200
D28-9001	201
D28-9002	201
E6/1	190
E6/2	191
E6/3	191
E8/2	189
F	201
HC	200
M1	189
M2	189
M3	188
MAG	228
MAGUV-	228
MD001-70	205
MD033-50	205
MD1618-50	203
MD181-70	206
MD184-70	206
MD8001-32	202
MD8002-40	202
MD8003-50	204
MD8004-40	202
MD8005-50	204
MD8006-40	203
MD8007-50	204
MD9607-50	203
MDCR001-70	207

CODICE	PAG
MDCR001-70-99	207
ME1	16
PASS 01	194
PASS 02	194
RI8010-07	210
RI8010-1	210
RI8010-11	210
RI8010-13	210
RI8010-24	210
RI8010-26	210
RI8010-27	210
RI8010-39	210
RI8020-07	210
RI8020-1	210
RI8020-11	210
RI8020-12	210
RI8020-BRI-14	210
RP8114	17 - 205
T11SW	198
T1G	195
T1S	195
T1W	195
T4GW	196
T4SS	196
T4SW	196
T7SS	198
T8GG	197
T8SS	197
TR	200
TR-25	211
TR-32	211
TR-50	211
TR-50X25	211
TR-60X25	211
TR-70X25	211
TR-PASUB2	197
TR-UV-25	211
TR-UV-32	211
TR-UV-50	211
TR-UV-50X25	211
TR-UV-60X25	211
TR-UV-70X25	211





WIN

PRODOTTI VINCENTI

